

**MODENA**

**User  
Manual Book  
Built-In Electric Hob**

BC 1640 LAM

# Table Of Content

PART 1: SAFETY WARNINGS	4
Electrical Shock Hazard And Cut Hazard	4
Important Safety Instructions	4
Operation And Maintenance Electrical Shock Hazard	5
Health Hazard	5
Hot Surface And Cut Hazard	5
Important Safety Instructions	6
PART 2: NAME OF PARTS	8
PART 3: INSTALLATION	9
Before Locating The Fixing Brackets	10
Easy Fit kits	10
Fix Clips To Hob:	10
Fix Hob To Cabinet	11
Connecting The Hob To The Main Power Supply	11
Installing The Electric Cooker On Kitchen Set Table	12
PART 4: HOW TO USE	13
Before Using Your New Hob	13
Using The Touch Controls	13
Choosing The Right Cook Ware	13
To Start Cooking	14
To Turn Off Hob	15
Beware Of Hot Surfaces	16
Using Large Heating Area-Ceramic Hob	16
Child Lock Safety Control	17
To Lock The Controls	18
To Unlock The Controls	18

Stop & Go function	18
Activate Stop & Go function	19
Deactivate Stop & Go function	19
Using The Timer	19
Time Overview	20
Using The Timer As A Minute Minder	20
Setting The Timer To Turn Cooking Zone Off	21
Detection of Pan and Small Articles	22
Residual Heat Warning	23
Auto Shutdown	23
Over-heat Protection	23
Over-flow Protection	23
Cooking Guidelines	24
Cooking Tips	24
Simmering, Cooking Rice	24
Searing Steak	24
For Stir-Frying	25
Heat Settings	25
PART 5: MAINTENANCE	27
Glass/Ceramic Surface	27
PART 6: TROUBLESHOOTING	28
PART 7: SPECIFICATION	31

## **PART 1: SAFETY WARNINGS**

Your safety is important to us. Please read below information carefully before installing or using your Hob.

### **Electrical Shock Hazard And Cut Hazard**

- Disconnect the appliance from the mains electricity supply before carrying out any work or maintenance on it.
- Connection to a good earth wiring system is essential and mandatory.
- Alterations to the domestic wiring system must only be made by MODENA Technician.
- Failure to follow this advice may result in electrical shock or death.
- Take care - panel edges are sharp.
- Failure to use caution could result in injury or cuts.
- Do not cook on a broken or cracked hob. If the hob surface should break or crack, switch the appliance off immediately at the mains power supply (wall switch) and contact MODENA technician.
- Switch the hob off at the wall before cleaning or maintenance.
- Failure to follow this advice may result in electrical shock or death.

### **Important Safety Instructions**

- No combustible material or products should be placed on the appliance at any time.
- In order to avoid a hazard, this appliance must be installed according to these instructions for installation.
- This appliance is to be properly installed and earthed only by MODENA Technician. By contact MODENA Customer Service.

- This appliance should be connected to a circuit which incorporates an isolating switch providing full disconnection from the power supply.
- Failure to install the appliance correctly could invalidate any warranty or liability claims.
- 

## **Operation And Maintenance Electrical Shock Hazard**

Electric cooker MODENA is specifically designed for long-term use so it does not require complex maintenance. However, there are some things that are recommended to treat your electric stove so that the quality of the stove is maintained.

## **Health Hazard**

- This appliance complies with electromagnetic safety standards.
- However, persons with cardiac pacemakers or other electrical implants (such as insulin pumps) must consult with their doctor or implant manufacturer before using this appliance to make sure that their implants will not be affected by the electromagnetic field.
- Failure to follow this advice may result in death.

## **Hot Surface And Cut Hazard**

- During use, accessible parts of this appliance will become hot enough to cause burns.
- Do not let your body, clothing or any item other than suitable cookware contact the ceramic glass until the surface is cool.
- Beware: Metallic objects such as knives, forks, spoons and lids should not be placed on the hob surface since they can get hot.
- Keep children away.
- Handles of saucepans may be hot to touch. Check saucepan handle do not overhang other cooking zones that are on. Keep handles out of reach of children.

- Failure to follow this advice could result in burns and scalds.
- The razor-sharp blade of a hob scraper is exposed when the safety cover is retracted. Use with extreme care and always store safely and out of reach of children.
- Failure to use caution could result in injury or cuts.

## **Important Safety Instructions**

- Never leave the appliance unattended when in use. Boil over causes smoking and greasy spillovers that may ignite.
- Never use your appliance as a work or storage surface.
- Never leave any objects or utensils on the appliance.
- Do not place or leave any magnet sable objects (e.g. credit cards, memory cards) or electronic devices (e.g. computers, MP3 players) near the appliance, as they may be affected by its electromagnetic field.
- Never use your appliance for warming or heating the room.
- After use, always turn off the cooking zones and the hob as described in this manual (i.e. by using the touch controls). Do not rely on the pan detection feature to turn off the cooking zones when you remove the pans.
- Do not allow children to play with the appliance or sit, stand, or climb on it.
- Do not store items of interest to children in cabinets above the hob. Children climbing on the hob could be seriously injured.
- Do not leave children alone or unattended in the area where the appliance is in use.
- Do not repair or replace any part of the appliance unless specifically recommended in the manual. All other service should be done by MODENA technician.
- Do not use steam cleaner to clean hob.
- Do not place or drop heavy objects on hob.

- Do not stand on your hob.
- Do not use pans with jagged edges or drag pans across the ceramic glass surface as this can scratch the glass.
- Do not use scourers or any other harsh abrasive cleaning agents for cleaning, as these can scratch the ceramic glass.
- If the power supply cable is damaged, it must only be replaced by MODENA technician.
- This appliance is intended to be used in household and similar applications such as: -staff kitchen areas in shops, offices and other working environments; -farm houses; -by clients in hotels, motels and other residential type environments; -bed and breakfast type environments.
- This appliance can be used by children aged from 8 years and above and persons with reduced physical, sensory or mental capabilities or lack of experience and knowledge if they have been given supervision or instruction concerning use of the appliance in a safe way and understand the hazards involved. Children shall not play with the appliance. Cleaning and user maintenance shall not be made by children without supervision.

## **WARNING!**

Unattended cooking on a hob with fat or oil can be dangerous and may result in fire. Never try to extinguish a fire with water, but switch off the appliance and then cover flame e.g. with a lid or a fire blanket.

## PART 2: NAME OF PARTS

### BC 1640 LAM

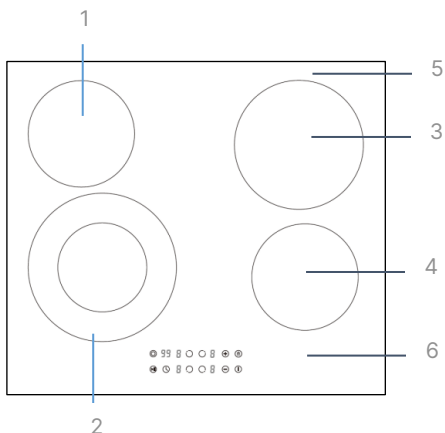

1. 1200W Cooking Zone
2. 2200W/1100W Dual Cooking Zone
3. 1800W Cooking Zone
4. 1200W Cooking Zone
5. Glass plate
6. Control panel

### Control Panel

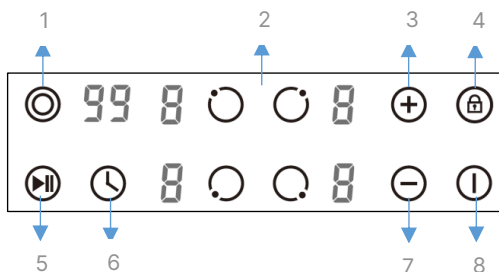

1. Extended zone control button
2. Cooking Zone selection button
3. Heating level/Timer "+" button
4. Child Lock control button
5. Stop & Go control button
6. Timer control button
7. Heating level/Timer "-" button
8. ON/OFF button



## PART 3: INSTALLATION

- Cut out the work surface according to the sizes shown in the drawing.
- For the purpose of installation and use, a minimum of 5 cm space shall be preserved around the hole.
- Be sure the thickness of the work surface is at least 30mm. Please select heat-resistant work surface material to avoid larger deformation caused by the heat radiation from the hotplate. As shown below:

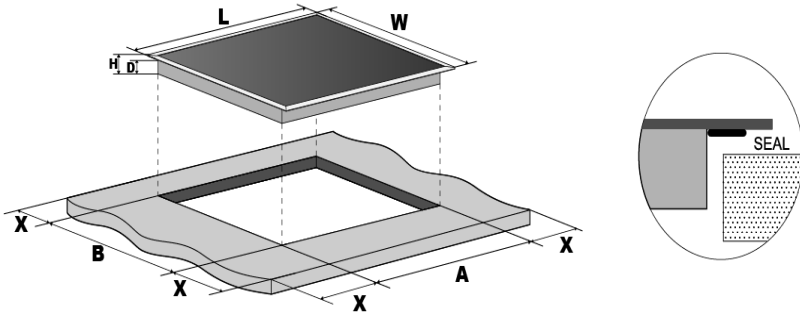

Model	L	W	H	D	A	B	X
BC 1640 LAM	590	520	52	48	555+5-0	495+5-0	50 min

### **NOTE:**

The safety distance between the hotplate and the cupboard above the hotplate should be at least 760mm.

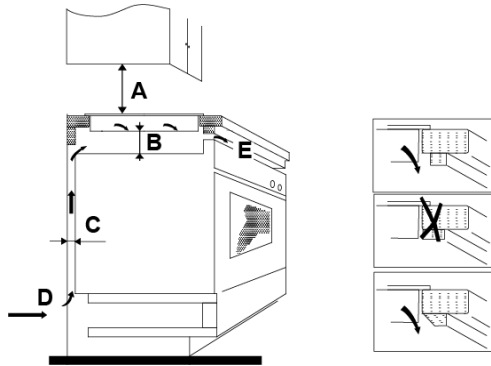

A (mm)	B (mm)	C (mm)	D	E
760 mm	50 mm minimal	20 mm minimal	Air Intake	Air exit 5 mm

## Before Locating The Fixing Brackets

The unit should be placed on a stable, smooth surface (use the packaging). Do not apply force on to the controls protruding from the hob.

## Easy Fit kits

There is one easy fit kits package for each hob, include fixing clips and screws (for ceramic hob there are total 2 pcs clip and 2 pcs screw, for induction hob there are total 4pcs clip and 4pcs screw). Find the easy fit kit package first.

### Fix Clips To Hob:

Insert the fixing clips into fixing holes reserved on 2 sides of housing, fix clip to housing with screw, then insert hob into cabinet/work surface.

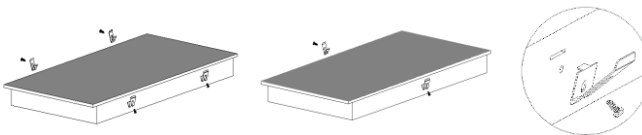

## Fix Hob To Cabinet

Insert the hob into the cabinet/work surface as below diagrams, the mounted clips on the sides can secure your hob sturdily.

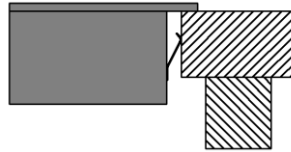
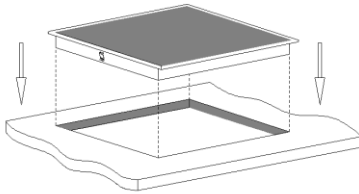

## Connecting The Hob To The Main Power Supply

The power supply should be connected in compliance with the relevant standard, or a single-pole circuit breaker. The appliance has a large power rating and must be connected to electricity by MODENA Technician.

### NOTES:

- If the cable is damaged or needs replacement, this should be done by MODENA technician using the proper tools, so as to avoid any accidents.
- If the appliance is being connected directly to the mains supply, an omnipolar circuit breaker must be installed with a minimum gap of 3mm between the contacts.
- The installer must ensure that the correct electrical connection has been made and that it complies with safety regulations.
- The cable must not be bent or compressed.
- The cable must be checked regularly and only replaced by MODENA technician.

# Installing The Electric Cooker On Kitchen Set Table

The connection method shown below:

## CAUTION:

1. The hob must be installed by MODENA technicians. Please never conduct the operation by yourself.
2. The electric hob shall not be mounted to cooling equipment, dishwashers and rotary dryers.
3. The electric hob shall be installed such that better heat radiation can be ensured to enhance its reliability.
4. The wall and induced heating zone above the work surface shall with stand heat.
5. To avoid any damage, the sandwich layer and adhesive must be heat resistant.
6. A steam cleaner is not to be used.
7. This electric hob can be connected only to a supply with system impedance no more than 0.427 ohm. In case necessary, please consult your supply authority for system impedance information.

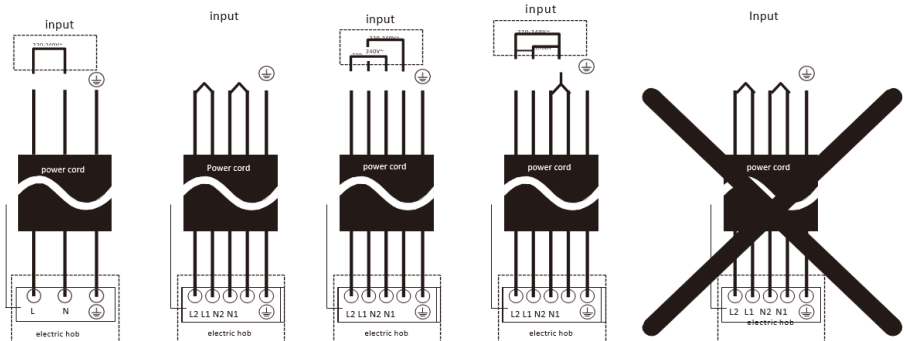

## PART 4: HOW TO USE

### Before Using Your New Hob

- Read this guide, taking special note of the Safety Warning section.
- Remove any protective film that may still be on your new electric hob.

### Using The Touch Controls

- The controls respond to touch, so you don't need to apply any pressure.
- Use the ball of your finger, not its tip.
- You will hear a beep each time a touch is registered.
- Make sure the controls are always clean, dry, and that there is no object (e.g. a utensil or a cloth) covering them. Even a thin film of water may make the controls difficult to operate

### Choosing The Right Cook Ware

- Only use cookware with a base suitable for induction cooking. Look for the induction symbol on the packaging or on the bottom of the pan
- You can check whether your cookware is suitable by carrying out a magnet test. Move a magnet towards the base of the pan. If it is attracted, the pan is suitable for induction hob.
- If you do not have a magnet:
  1. Put some water in the pan you want to check.
  2. If  does not flash in the display and the water is heating, the pan is suitable.
- Cookware made from the following materials is not suitable for an induction hob: pure stainless steel, aluminum or copper without a magnetic base, glass, wood, porcelain, ceramic, and earthen ware.

- Induction hobs are made from smooth, ceramic glass, the heat comes from a magnetic induction coil which heats the cook ware but not the cooking surface. The heat from the cook ware is transfer red to the food.
- It's important that you use only metal pans specifically designed and/or approved for use on induction hobs.
- Never allow melamine or plastic containers to come in contact with the heat zones

Do not use cookware with jagged edges or a curved base.



Make sure that the base of your pan is smooth, sits flat against the glass, and is the same size as the cooking zone. If you use smaller pot efficiency could be less than expected. Always centre your pan on the cooking zone.

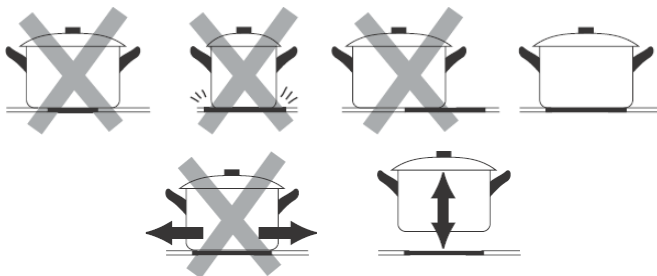

Always lift pans off the electric hob – do not slide, or they may scratch the glass.

## To Start Cooking

1. After the hob be connected to electricity and power on Press and hold the ON/OFF  control button for about 3 seconds till you hear a “beep” to turn the hob on. Now the hob enters into Standby mode, all heat



setting indicators and Timer setting indicators shows "--"

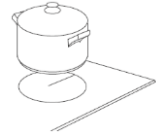

2. Place a suitable pan on the cooking zone you wish to use. Make sure the bottom of the pan and the surface of the cooking zone are clean and dry.

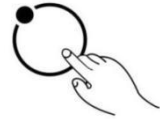

3. Set heating level of cooking zone Before adjust heating level, need to touching the heating zone selection control button to select and active the cooking zone you wish to use. The heat setting indicator of the selected zone flashing when be active, then you could adjust its heat level by below:



- Touch control model of BC 1640 LAM

- A. Set heat setting by touching the  or button 
- B. If press and hold either of the two buttons, the value will be adjusted down or up rapidly, from 0 to 9 in circle.

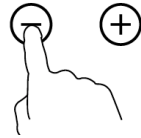

## To Turn Off Hob

1. You can turn the cooking zone off by adjust heat setting to level 0, which indicator shows "--".
2. You can also turn the whole hob off by touching the ON/OFF control button.

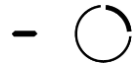

## NOTES:

1. After connected to electricity, when power on, the buzzer of hob beeps once, all indicators light on for 1 second then off.
2. When the hob in Standby mode, if there is no practice within 1 minute, the electric hob will auto turn off, with buzzer beeps once.
3. You can modify the heat setting at any time during cooking. The heating element will turn off under power level 0, with indicator shows “-”
4. The heat setting indicator of the selected zone will flash when adjusting. After adjusting, the number in indicator will flash for 5 seconds and then stop flash, then the setting has been confirmed.
5. If there is power cut off during cooking, all programmers setting will be cancelled, you need to reset the programmer again.
6. The cooling fan of induction hob will remain on for about 1 minute after the hob is turned off.

## Beware Of Hot Surfaces

After turn off, the **H** will show in the power setting indicator if cooking zone is hot to touch. It will disappear when the surface has cooled down to a safe temperature. When in Standby mode, if the surface of cooking zone is hot to touch, the letter “H” and “-” will show in its heat setting indicator alternately.

## Using Large Heating Area-Ceramic Hob

Some of **ceramic hob** models might have one or several extended cooking zones (Oval/Dual/Triple zone), these extended zones can provide larger cooking area and additional heat to fit for different size of cooking pan.



**To use Extended zone when hob is working, follows below:**

1. Select and active the cooking zone which you would like to use extended zones, for those cooking zone with this feature. Touch the heating zone selection control button to select and active it for adjustment.
2. The central zone will be switched on, when first adjust of heat level for extended cooking zone.
3. When the heating zone be selected and active (power level indicator flashing), touch extended zone control button to active extended heating element to get a large heating area.



**NOTES:**

1. By continuous touch the control button, the extended zones work at below consequence:
  - Oval zone: "Central-Oval-Central-Oval-Central zone..."
  - Dual zone: "Central-Dual-Central-Dual-Central zone..."
  - Triple zone: "Central-Dual-Triple-Central-Dual-Triple-Central zone..."
2. When the Dual Zone of extended cooking zone active, the LED indicator of it will show heat setting and  alternately.

**Child Lock Safety Control**

- You can lock the controls to prevent unintended use (for example children accidentally turning the cooking zones on) by active Child Lock function.



- When the controls are locked, except the ON/OFF control button and Child Lock control button, all other touch control buttons are disabled.

### To Lock The Controls

Touch the Child Lock control button  once. The timer indicator will show “Lo”, and Child Lock function is activated.

### To Unlock The Controls

1. Make sure the electric hob is turned on.
2. Touch and hold the Child Lock control button  for 3 seconds, the buzzer beeps once and “Lo” disappears in timer indicator, the Child Lock be inactive.
3. You can now start using your electric hob.

Under the child lock mode, all controls button are disable except the ON/OFF  and child lock . You can always turn the hob off with the ON/OFF  control in an emergency, but you shall unlock the hob first in the next operation.

#### **NOTES:**

Under Child Lock function, if you turn the hob off, the Child Lock function will still be activated. If you want to turn on the hob after that, you need to deactivate Child Lock function first.

### Stop & Go function

- **Make cooking easy!** When cooking, your door bell rings, phone rings, or kid shouts from another door. Need to step out of kitchen? These means dinner could burn, or take longer time to ready if you switch everything off.

- The **Stop & Go function** can turn <sup>off</sup> all zones. When you back, with one more touching of the button , hob restarts where they were, to carry on cooking.

### Activate Stop & Go function

To active **Stop & Go** function, you can press the **Stop & Go** function button once. Then all programmer setting be hold on and hob stop heating, all heat setting indicators show “P”.

### Deactivate Stop & Go function

To cancel **Stop & Go** function, you can press the **Stop & Go** function again, after come back. Then all Programmer setting will return to what they were, Stop & Go indicator “P” disappear from all indicators. When **Stop & Go** function is active, all of the control buttons are disable except the ON / OFF and Stop & Go Button.

#### **NOTES:**

The hob will auto turn off, if Stop & Go function last more than 10 minutes.

### Using The Timer

When the hob is turned on, you can use the timer in two different ways:

- You can use it as a minute minder. In this case, the timer will not turn any cooking zone off when the set time is up.
- You can set it to turn either or more than one cooking zones off.
- You can set the minute minder/timer for up to 99 minutes.

## Time Overview

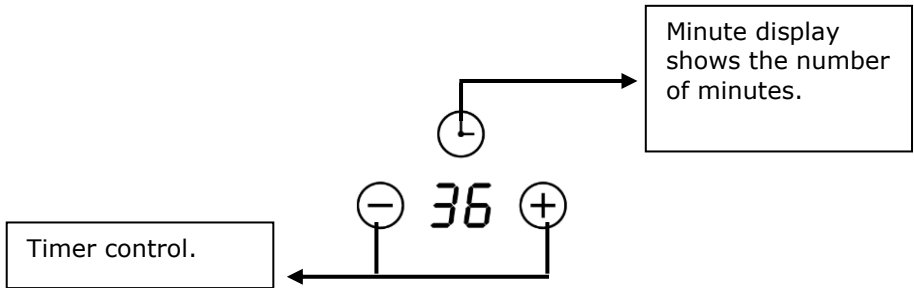

## Using The Timer As A Minute Minder

If you have not selected any cooking zones

1. Touch the timer control button  the number in timer indicator flashing.
2. Then adjust Minute Minder setting follows below:



### 1) Touch control models: BC 1640 LAM

- Set heat setting by touching the plus or minus button. If press and hold either of the two buttons, the value will adjust down or up rapidly in circle.

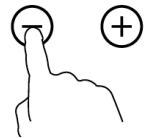

### NOTES:

When the timer indicator flashing, touch timer control button another time, can quick confirm the timer setting.

### NOTES:

By continuous touch the timer control button, the slider works at below consequence: "Single Digit-Tens Digit-Confirm Setting-Single Digit-..."

- When the minute minder is set, it will begin to count down immediately, the display will show the remaining time.
- Buzzer will beep for 30 seconds and timer indicator shows "--" when the setting time finished. Any efficient touching of control buttons during it, would end up the buzzer beeps.

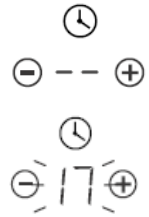

### Setting The Timer To Turn Cooking Zone Off

- Touch the heating zone selection control button to select the cooking zone you wish to set timer for.
- Touch the timer control button  the number in timer indicator flashing.
- Then adjust timer setting



#### 1) Touch control models: BC 1640 LAM

- Set heat setting by touching the plus or minus button.
- If press and hold either of the two buttons, the value will adjust down or up rapidly in circle.

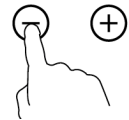

#### NOTES:

When the timer indicator flashing, touch timer control button another time, can quick confirm the timer setting.

#### NOTES:

By continuous touch the timer control button, the slider works at below consequence: "Single Digit-Tens Digit- Confirm Setting - Single Digit-..."

4. When the timer is set, it will begin to count down immediately, the display will show the remaining time.

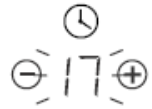

### NOTES:

- The red dot next to power level indicator will illuminate for those zones be set with timer. You can check timer setting of different cooking zone which set with timer, by activate this cooking zone.
- If more than one heating zone has timer setting, the timer indicator will show the lowest time. The red dot next to power level indicator will flash.

5. When cooking timer expires, the corresponding cooking zone will be switch off automatically.

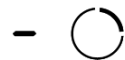

### Detection of Pan and Small Articles

**For induction hob, if the display flashes "E" in heat setting indicator.**

- You have not placed a pan on the correct cooking zone
- the pan you're using is not suitable for induction cooking,
- the pan is too small or not properly centered on the cooking zone.

## NOTES:

- No heating takes place unless there is a suitable pan on the cooking zone.
- The hob will auto turn off after 2 minutes if no suitable pan is placed on it.
- When an unsuitable size or non-magnetic pan (e.g. aluminum), or some other small item (e.g. knife, fork, key) is left on the hob, the hob automatically go to standby in 1 minute. The fan will keep cooking down

## Residual Heat Warning

When the hob has been operating for some time, there will be some residual heat. The letter " H " appears to warn you to keep away from it.



## Auto Shutdown

Another safety feature of the hob is auto shutdown. This occurs whenever you forget to switch off a cooking zone. The default shutdown times as below table:

Power level	1	2	3	4	5	6	7	8	9
Default working time (hour)	8	8	8	4	4	4	2	2	2

## Over-heat Protection

A temperature sensor equipped can monitor the temperature inside the hob. When an excessive temperature is monitored, the hob will auto stop operation.

## Over-flow Protection

For your safety, the programmer will auto shut off the power if liquid boiling or wet cloth over touch control panel. All control buttons became

invalid except ON/OFF and Child Lock button, unless you wipe the touch control area dry.

## **Cooking Guidelines**

### Cooking Tips

- When food comes to the boil, reduce the power setting.
- Using a lid will reduce cooking times and save energy by retaining the heat.
- Minimize the amount of liquid or fat to reduce cooking times.
- Start cooking on a high setting and reduce the setting when the food has heated through.

### Simmering, Cooking Rice

- Simmering occurs below boiling point, at around 85°C, when bubbles are just rising occasionally to the surface of the cooking liquid. It is the key to delicious soups and tender stews because flavors develop without overcooking the food. You should also cook egg-based and flour thickened sauces below boiling point.
- Some tasks, including cooking rice by the absorption method, may require a setting higher than the lowest setting to ensure the food is cooked properly in the time recommended.

### Searing Steak

To cook juicy flavor some steaks:

1. Stand the meat at room temperature for about 20 minutes before cooking.
2. Heat up a heavy-based frying pan.
3. Brush both sides of the steak with oil. Drizzle a small amount of oil into the hot pan and then lower the meat onto the hot pan.



4. Turn the steak only once during cooking. The exact cooking time will depend on the thickness of the steak and how cooked you want it. Times may vary from about 2 – 8 minutes per side. Press the steak to gauge how cooked it is – the firmer it feels the more ‘well done’ it will be.
5. Leave the steak to rest on a warm plate for a few minutes to allow it to relax and become tender before serving.

### For Stir-Frying

1. Choose an ceramic compatible flat-based wok or a large frying pan.
2. Have all the ingredients and equipment ready. Stir-frying should be quick. If cooking large quantities, cook the food in several smaller batches.
3. Preheat the pan briefly and add two tablespoons of oil.
4. Cook any meat first, put it aside and keep warm.
5. Stir-fry the vegetables. When they are hot but still crisp, turn the cooking zone to a lower setting, return the meat to the pan and add your sauce.
6. Stir the ingredients gently to make sure they are heated through.
7. Serve immediately.

### Heat Settings

The settings below for **induction hob** are guidelines only. The exact setting will depend on factors including your cookware and the amount you are cooking. Experiment with the induction hob to find the settings that best suit you.

Heat setting	Suitability
1 - 2	<ul style="list-style-type: none"> <li>• Delicate warming for small amounts of food</li> <li>• Melting chocolate, butter, and foods that burn quickly</li> <li>• Gentle simmering</li> <li>• Slow warming</li> </ul>

Heat setting	Suitability
3 - 4	<ul style="list-style-type: none"> <li>• Reheating</li> <li>• Rapid simmering</li> <li>• Cooking rice</li> </ul>
5 - 6	<ul style="list-style-type: none"> <li>• Pancakes</li> </ul>
7 - 8	<ul style="list-style-type: none"> <li>• Sautéing</li> <li>• Cooking pasta</li> </ul>
9	<ul style="list-style-type: none"> <li>• Stir-frying</li> <li>• Searing</li> <li>• Bringing soup to the boil</li> <li>• Boiling water</li> </ul>

## **PART 5: MAINTENANCE**

The MODENA Electric cooker is designed specifically for long term usage and does not require complicated maintenance. However, there are several advices on how to maintain the quality of your stove.

### **Glass/Ceramic Surface**

- Clean the dirty part of the glass / ceramic using a wet cloth or a special glass / ceramic cleaner, and then dry it using a fine cloth.
- if any spillage becomes burnt on, remove with a ceramic glass cleaner or scraper and clean with a cleaner-conditioner containing silicone.
- Do not allow the ceramic glass surface to become scratched or damaged as this could lead to a hazard.

### **ATTENTION!**

- Glass/ceramic must be cleaned under cool condition, unless stained with sugar or liquid with high content of sugar, in which case the glass/ceramic must be immediately cleaned, (be careful when doing this, as there's a risk of burn).
- Always turn off the cooking zone and unplug the power cord from the power outlet when necessary before cleaning your induction cooker.
- Do not use any cleaning agent that can damage the glass/ceramic.
- Use a fine cloth and avoid scratching your glass/ceramic.

## PART 6: TROUBLESHOOTING

Problem	Possible Cause	Recommended Action
<p>Everyday soiling on glass (fingerprints, marks, stains left by food or non- sugary spillovers on the glass)</p>	<ul style="list-style-type: none"> <li>• Switch off the power supply.</li> <li>• Apply a vitro-ceramic glass cleaner while the glass is still warm (but not hot!)</li> <li>• Rinse and wipe dry with a clean cloth or paper towel.</li> <li>• Switch on the power supply to the hob.</li> </ul>	<ul style="list-style-type: none"> <li>• When turn off the power supply of hob, there will be no 'hot surface' indication but the cooking zone may still be hot! Take extreme care.</li> <li>• Heavy-duty scourers, some nylon scourers and harsh/abrasive cleaning agents may scratch the glass. Always read the label to check if your cleaner or scourer is suitable.</li> <li>• Never leave cleaning residue on the hob glass surface: the glass may become stained.</li> </ul>
<p>Boil over, melts, and hot sugary spills on the glass</p>	<p>Remove these immediately with a fish slice, palette knife or razor blade scraper suitable for ceramic glass of hob, but beware of hot cooking zone surfaces:</p> <ul style="list-style-type: none"> <li>• Switch off the power supply.</li> <li>• Hold the blade or utensil at a 30° angle and scrape the soiling or spill to a cool area of the hob.</li> <li>• Clean the soiling or spill up with a dish cloth or paper towel.</li> <li>• Follow steps 2 to 4 for 'Everyday soiling on glass' above.</li> </ul>	<ul style="list-style-type: none"> <li>• Remove stains left by melts and sugary food or spillovers as soon as possible. If left to cool on the glass, they may be difficult to remove or even permanently damage the glass surface.</li> <li>• Cut hazard: when the safety cover is retracted, the blade in a scraper is razor-sharp. Use with extreme care and always store safely and out of reach of children.</li> </ul>

Problem	Possible Cause	Recommended Action
Spillovers on the touch controls	<ul style="list-style-type: none"> <li>• Switch off the power supply.</li> <li>• Soak up the spill</li> <li>• Wipe the touch control area with a clean damp sponge or cloth.</li> <li>• Wipe the area completely dry with a paper towel.</li> <li>• Switch on the power supply to the hob.</li> </ul>	<ul style="list-style-type: none"> <li>• The hob may beep and turn It self off, and the touch controls may not function while there is liquid on them. Make sure you wipe the touch control area dry before turning the hob back on.</li> </ul>

If you find something goes wrong for your hob, before contact the service or where you purchased it, please check whether below:

1. There is no power to the appliance:

- Check whether there is a power cut of your department.
- Check whether the appliance be connected to electricity properly.
- Has the timer setting elapsed.
- Whether it reaches the longest cooking time setting and auto shut off.
- Whether there is liquid boiling over touch control panel and overflow protection devices auto shut off.

2. The touch control panel buttons can't be active:

- Whether it's under "Child Lock", which there is "Lo" shows in timer displayer.
- Whether liquid/wet cloth over touch control panel active overflow protection.

3. After cooking there is "H" shows on display:

- This is normal. The hob is with Residual Heat Warning safety features. It will remain on until the surface is cool enough for touch.

4. After turn off, the fan of induction hob remains working for a while:

- This is normal, this is to help appliances completely cool down.

5. Some pans make crackling or clicking noises during use of induction hob:

- This is normal, it's the sound of induction coils during working, and for different construction of your cookware, the clicking might be slightly different.

6. The glass is being scratched:

- Check whether you use unsuitable cookware, like rough-edged cookware.

- Check whether unsuitable, abrasive scourer or cleaning products are being used.

If an abnormality comes up, the induction hob will enter the protective state automatically and display corresponding protective codes:

Problem	Possible causes	What to do
E1/E2	Abnormal supply voltage	Please check whether power supply is normal, Power on after the power supply is normal.
E3	High temperature of the pan sensor	Check whether no liquid in pan, fill with liquid then restart.
E5	High temperature of the IGBT temperature sensor	Please restart after the induction hob cools down.

## PART 7: SPECIFICATION

MODEL	BC 1640 LAM
Type	Vitroc ceramic Hob
Number of burners	4
Burner composition	Ø200 mm (1800 W) x 2 Ø165 mm (1200 W) x 1 Ø138 - 230 mm (1100/2200 W) x 1
Blocking securing system	Yes
Color	Black
Touch control panel	Yes
Program / Timer	Digital
Lock system	Yes
Electricity (Volt)	220-240
Electric frequency (Hz)	50-60
Dimension (P x L x T) mm	590 x 520 x 51
Cut off Dimension (L x W) mm	555 x 495
Weight (kg)	8.6

