

User

Manual Book

Vacuum Cleaner

Preciso Series

VC 2025, VC 2125

Latore Series

VC 2071 S, VC 3071 S

Nettare Series

VC 3143

MODENA

Thank you for your trust in choosing MODENA products for your household needs. With your satisfaction as our priority, we constantly aim to deliver stylishly designed products equipped with state-of-the-art technology to assist you in your daily activities.

This is your guidebook containing everything you need to know about our product. Please reach out to us if you need further assistance or other information via our Customer Care or our official website www.modena.com.

MODENA

CONTENTS

PAGE.

• Introduction	1
• Part 1 : Name of Parts	3
• Part 2 : Installation	5
• Part 3 : How to Use	8
• Part 4 : Maintenance	9
• Part 5 : Precaution Action	10
• Part 6 : Problem & Solution	11
• Part 7 : Specification	12

Part 1: Name of Parts

VC 3071 S & VC 2071 S

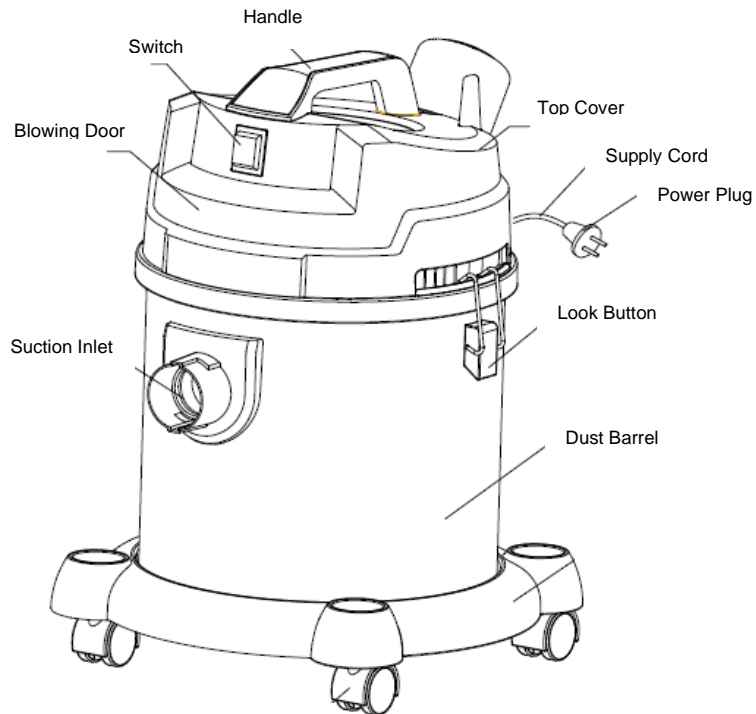

VC 3143

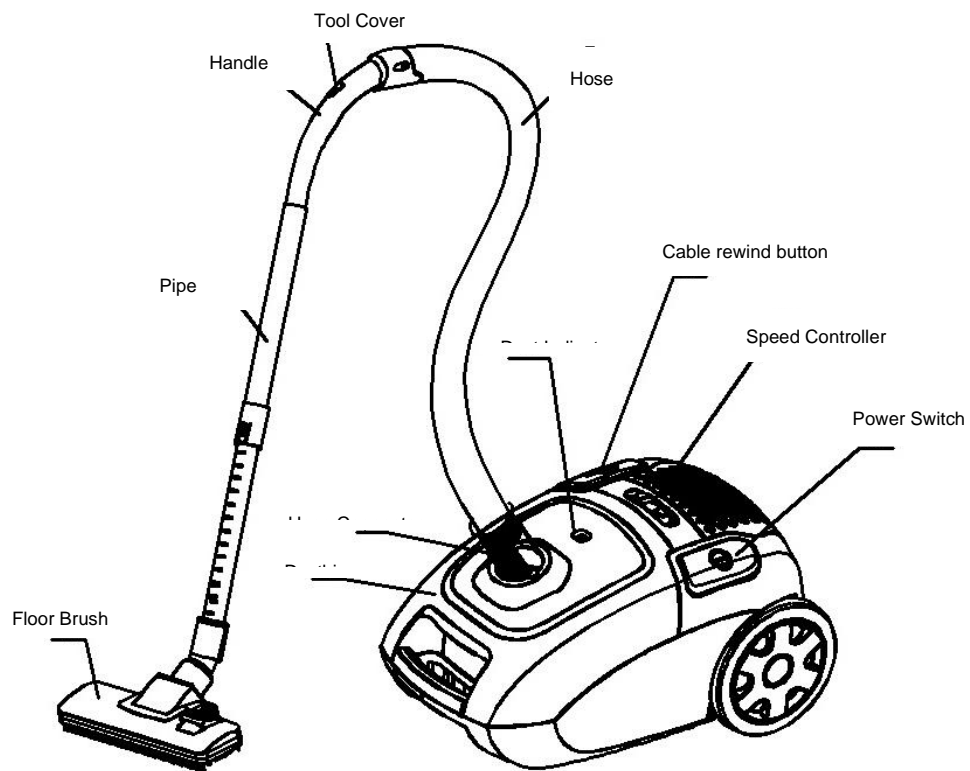

VC 2125

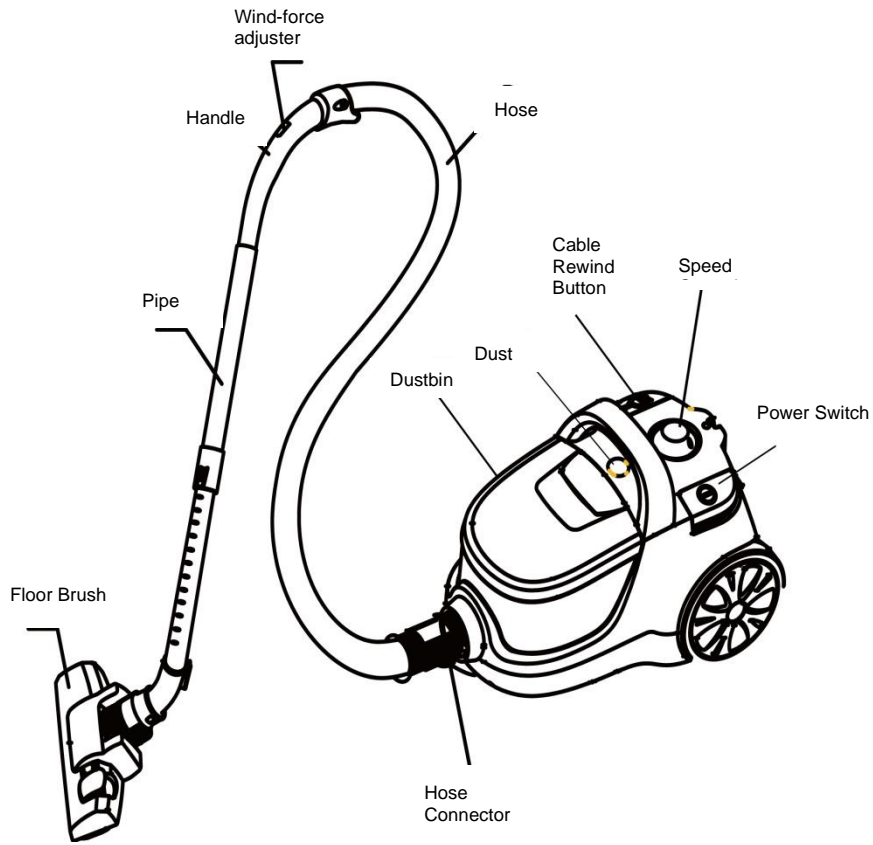

VC 2025

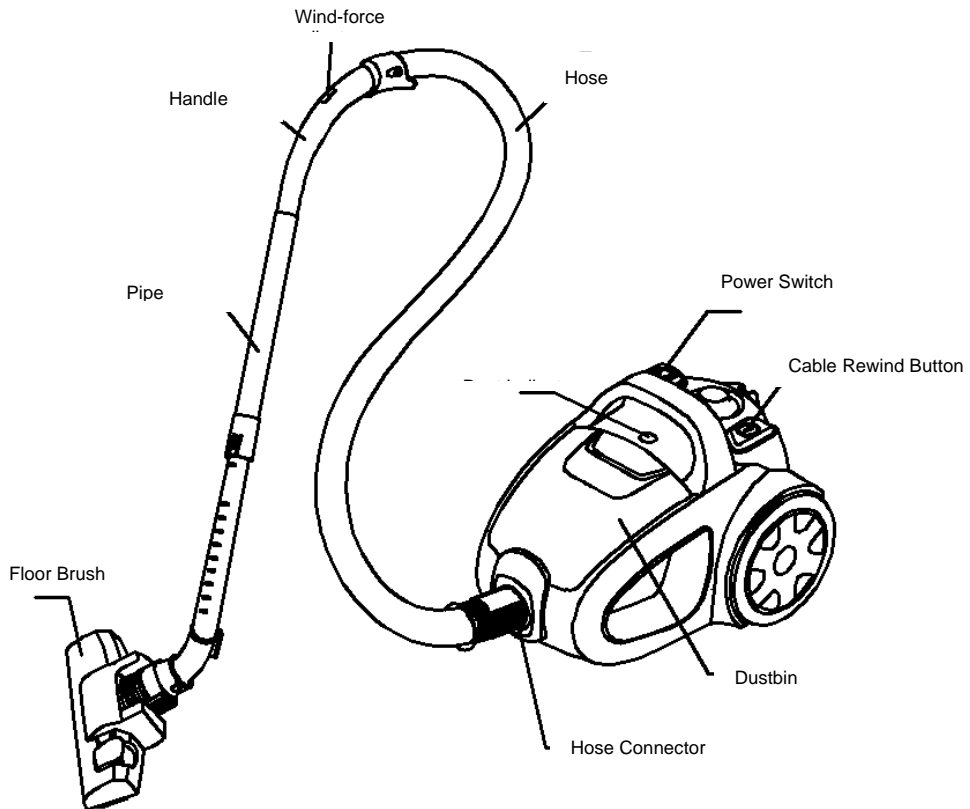

NOZZLE:

1. Floor /Carpet



- Extend / deploy the brush to clean the hard floor surface.



- Pull /retract the brush to clean the carpet.

2. Gap



- Used for radiator, gap, corner and gap between the sofa cushions.

3. Small brush



- Used to clean the curtain, books, shelf, lamp shade and other similar objects.

* Features depend on the type of product.

Part 2: Installation

Important:

1. Read this manual thoroughly before starting operations.
2. Check whether the voltage specified on the unit fits with the one in your house. If not contact MODENA Call Center for further inquiries.
3. Unit must be connected with a properly grounded 10A electrical outlet.
4. Always unplug the power cord before installing / detaching accessories, disassembling the unit, when the unit is not to be used for a long time, or before cleaning and repairing.
5. Do not use solvent substances (methylated spirits) to clean the unit
6. Do not use the unit on wet surface.
7. When the unit is activated, do not leave it without supervision. Make sure to keep it away from children or incompetent people.
8. The unit is meant for house hold usage. Use it according to the instructions provided in the manual.
9. Do not activate the unit if the unit is damaged.
10. Contact the dealer or call center for repairs and after sales service.
11. If the power cord is damaged, contact MODENA call center for replacement.
12. This unit is not meant to be used by children, mentally or physically challenged, or those who lack the experience and knowledge regarding the unit. For safety precautions, provide serious instructions and guidance when they attempt to do operations.
13. Keep the unit away from children's reach.
14. If you wish to unplug the power cord from the socket, pull the plug, not the cord. If the power cord is damaged, both cord and the plug must be repaired by a qualified technician.
15. If the dust indicator light turns red, immediately replace or clean the dust container.
16. Replace or clean the dust container on a regular basis to prolong the product's age.
17. Make sure the front cover is always attached.

CONNECTING THE VACUUM CLEANER

Remove flexible pipe

Remove the cord plug from the socket before releasing the flexible pipe from the air inlet.

VC 3071 S & VC 2071 S

Push and rotate the flexible tube towards the lock position to insert the hose.

Pull and rotate the flexible tube towards open to remove.

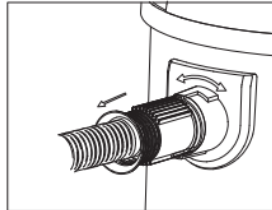
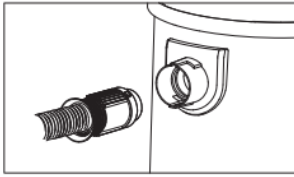

VC 3143, VC 2125, VC 2025

Press the button at the end of the flexible pipe and pull it to release.

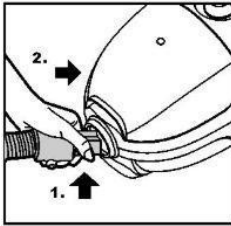

Installing and connecting additional pipes and accessories

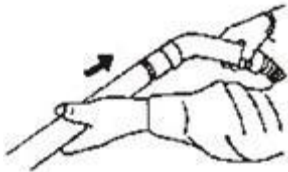

- Install additional pipes on the handle.

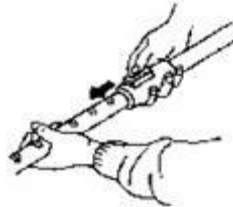

- Connect additional pipes.

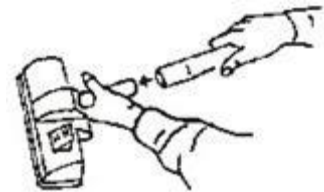

- Install accessories to the additional pipe.

Emptying and replacing the dust bag

VC 3071 S & VC 2071 S

1. Release the lock and lift the top cover.
2. Take out the whole top cover including the filter bag.

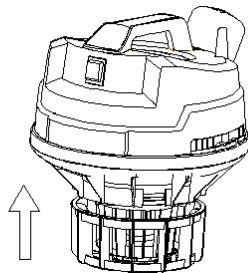
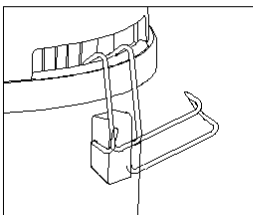

Filter Bag

3. Remove the filter bag and clean the dust in the barrel
4. Put the bag and the top cover back to its place.

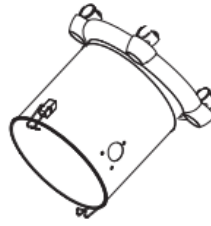
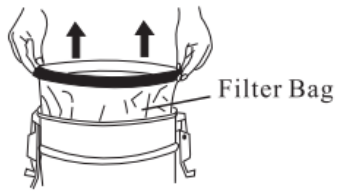

VC3143, VC2125, VC2025

After removing the flexible pipe, open the cover by pressing the lock button and pull it upwards. Remove the dust bag.

VC 3143

1. Open the front cover by pressing the button and pulling it upwards.
2. Clean the dust bag and reinstall it to the unit.

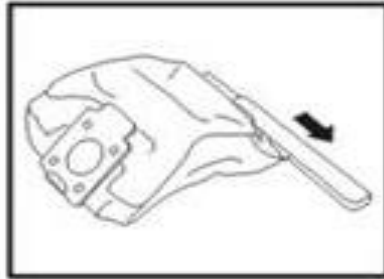
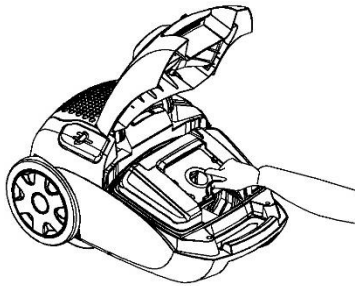

VC 2125

1. Open the front cover by pressing the button and pulling it upwards.
2. Clean the dust bag and reinstall it to the unit.

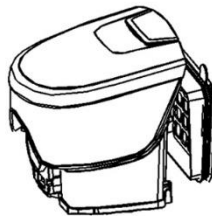
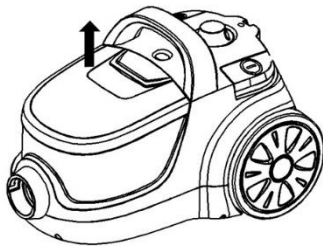

VC 2025

1. Open the front cover by pressing the button and pulling it upwards.
2. Clean the dust bag and reinstall it to the unit.

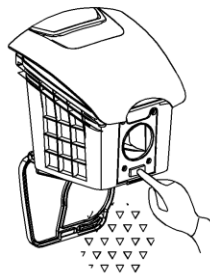
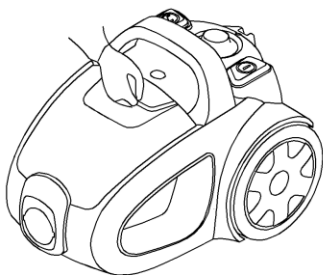

a. Type of cloth dust

1. Cloth

To remove the dust from the cloth dust bag, remove the pins on the bottom of the bag to release the dirt inside the bag, clean the bag and pin the bottom part again.

2. Paper

If you use a dust bag made from paper, throw away the bag after usage.

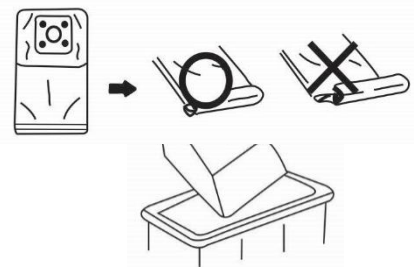

Part 3: How to Use

1. Before usage, pull / detangle the power cord as necessary and connect the power cord head to the socket. Red represents the maximum efficient length of cord. Do not pull the cord beyond the red mark. To roll the power cord, press the cord roller button with one hand and detangle the cord with one other hand.
2. Press the On/Off button to activate / turn on the unit. Set the vacuum power to MIN before activating the unit.
3. The vacuum power can be adjusted according to the needs by turning the vacuum power button.

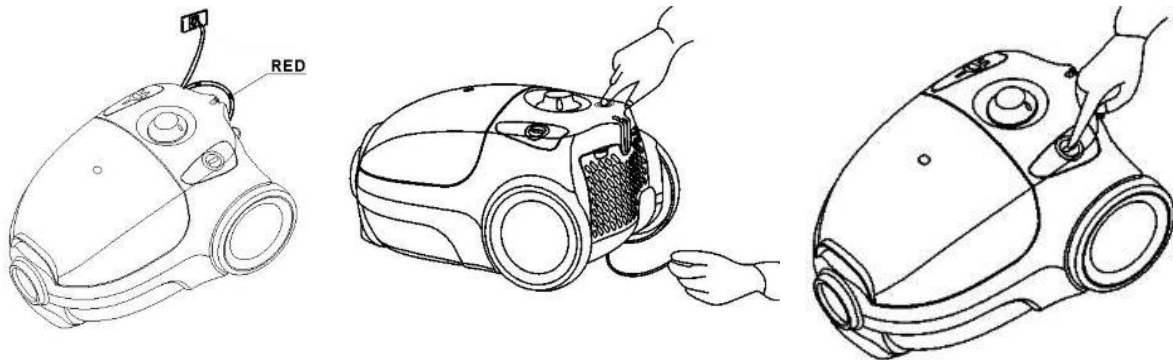

4. Nozzle brush usage.

- Floor/Carpet

Extend / release the brush to clean the hard floor surface.



Retract / pull the brush to clean the carpet.

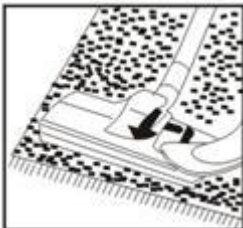

- Small brush

Used to clean the dust on the curtain, book, shelf, lampshade and other objects.

- Gap

Used to clean the gap, corner, radiator and the gap between the sofas.

5. When it's used to suck water, please take out the filter bag.
For Model: VC 2071 S & VC 3071 S



6. After usage, turn off the vacuum cleaner by pressing the ON/OFF and reroll the power cord.
7. For certain models, do not move the vacuum cleaner when the cleaning pipe is not hooked perpendicularly to the hole / hook on the unit. This may cause the floor to get scratched from the brush nozzle.

Part 4: Maintenance

Always remove the plug from the socket before performing maintenance on the vacuum cleaner.

1. Clean the unit using dry cloth. Do not use shining powder, detergent, gasoline, acid, thinner, oil or hot water to clean any part of the unit.
2. Remove the inlet and outlet air filter, clean the filter by submerging it in warm water, and dry it inside out. After it's dried, reinstall it to the vacuum.

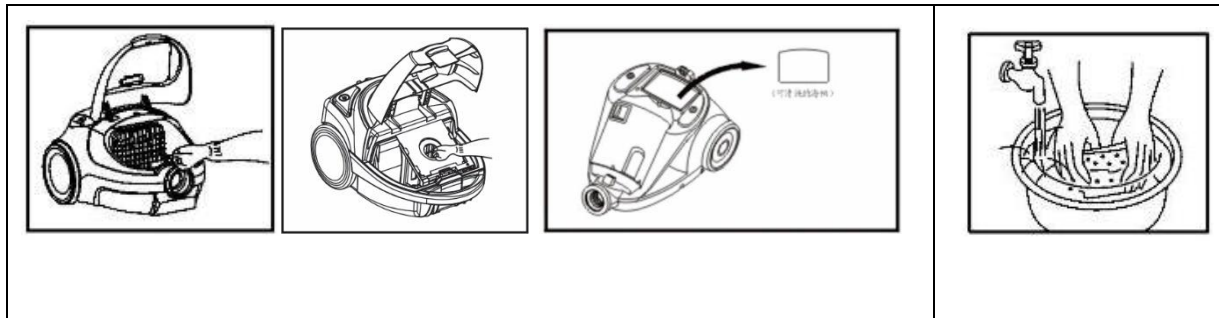

- Make sure the filter is dry when reinstalled on the vacuum cleaner.
- Make sure it is placed in its proper place.

If the unit is not going to be used for a long time, store it in a dry place with good circulation. Keep away from children.

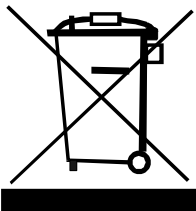

DISPOSAL Environmental Preservation

Electronic waste should not be disposed of with household waste. Dispose properly at an electronic dump site. Ask for advice from the retailer or the local authorities on how to perform proper disposal and recycle.

Part 5: Precaution Action

Perform the following preventive measures before operating the vacuum cleaner:

- Read all instructions thoroughly and pay attention to the pictures before operating the vacuum cleaners.
- Check the voltage specifications on the vacuum cleaner whether it matches with the voltage in your house. If it doesn't match, contact the MODENA Call Center for further information.
- Do not leave the vacuum cleaner while it is still connected to the socket. Always unplug the power cord from the socket if the vacuum cleaner is not used.
- To avoid electric shock, do not use the vacuum cleaner outside the house or out in the open area and do not put or submerge the power cord or plug in the water or liquid substance.
- Tight supervision is required if vacuum cleaner is used around the children.
- Do not operate the vacuum cleaner if the power cord or the plug is damaged, dysfunctional, taking fall damage, or broken. Take it to our Call Center for inspection & testing, rearrangement of electrical or mechanical functions, and necessary repairs.
- Usage of additional equipment/tools without recommendations and not supplied by the manufacture may result in fire, electric shock / shortage and damage to the vacuum cleaner.
- Special attention is required for usage on stairs.
- If the air inlet, pipe nozzle or telescopic pipe is obstructed, immediately deactivate the vacuum cleaner and clear the obstruction before restarting it.
- Make sure you plug the power cord to the socket with dry hands.
- Remove large or sharp objects on the floor before using the vacuum cleaner to avoid damages to the filter.
- If you wish to unplug the power cord from the socket, pull the plug, not the cord. The damaged cord and plug must be repaired by a qualified technician.

Do not operate vacuum cleaner near heat sources such as stove, cigarette buds, etc.



Do not use the unit on top of the power cord. Make sure the power cord is not pinned or stepped on when the unit is operating.

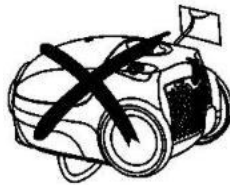

Do not use the unit to vacuum / clean lighted match, lighted cigarette or hot dust.



Do not use the unit on wet surface.



Do not obstruct the air inlet or the drainage.

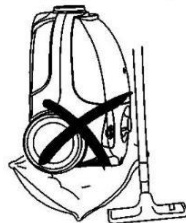

Do not use the unit to vacuum / clean threads, sharp objects, nails, pins, etc.



Part 6: Problem & Solution

In the event of operational issues, check the following problems and solutions below before contacting our Call Center:

Problem	Cause	Solution
Weak Suction Power	<ul style="list-style-type: none">- Dust bag and the cylindrical filter are obstructed.- Brush or nozzle are obstructed.- Flexible pipe is obstructed.	<ul style="list-style-type: none">- Replace or clean the dust bag and the cylindrical filter.- Clean the brush and nozzle from dust.- Clean the flexible pipe
The motor cannot rotate / vacuum	<ul style="list-style-type: none">- Is the cord plugged to the socket?- Has the ON button been pressed yet?	<ul style="list-style-type: none">- Reconnect the power cord with the socket.- Press the ON Button

Part 7: Specification

VACUUM CLEANER	VC 3071 S	VC 2071 S	VC 3143
Type	Wet & Dry	Wet & Dry	Dry
Color	Stainless	Stainless	Blue
Nozzle material	Fiber	Fiber	Fiber
Main Feature			
Blower function	Yes	Yes	No
Cloth filter	Yes	Yes	Yes
Cloth paper	No	No	No
Filter for motor / cylinder	Yes	Yes	Yes
Filter for blower	Yes	Yes	No
Overload safety / Motor	Yes	Yes	Yes
Wheel	Yes	Yes	Yes
Suction controller	No	No	Yes
Accessoris			
Nozzles	3	3	3
Flexible hose	1	1	1
Pipe	1	1	1
Exhaust filter	1	1	1
Technical Features			
Capacity (liter)	30	20	4
Cable length (meter)	4.5	4.5	4.5
Noise level (dbA)	< 83	< 81	< 78
Suction power (kPa)	21	21	26
Power Consumption (watt)	1200	1000	1200
Product Dimension			
Depth(mm)	390	390	471
Width(mm)	370	370	316
Height (mm)	632	497	250
Gross Weight (Kg)	7.7	7.3	5.8

VACUUM CLEANER	VC 2125	VC 2025
Type	Dry(cyclone)	Dry(cyclone)
Color	Red	Blue
Nozzle material	Fiber	Fiber
Main Feature		
Blower function	No	No
Cloth filter	No	No
Cloth paper	No	No
Filter for motor / cylinder	Yes	Yes
Filter for blower	No	No
Overload safety / Motor	Yes	Yes
Wheel	Yes	Yes
Suction controller	Yes	Yes
Accessoris		
Nozzles	3	3
Flexible hose	1	1
Pipe	1	1
Exhaust filter	1	1
Technical Features		
Capacity (liter)	2	2
Cable length (meter)	4.5	4.5
Noise level (dbA)	< 82	< 82
Suction power (kPa)	23	23
Power Consumption (watt)	1200	1200
Product Dimension		
Depth(mm)	408	383
Width(mm)	295	285
Height (mm)	270	275
Gross Weight (Kg)	5.1	5.1

S = Stainless W = White V = Silver G = Grey L = Black Y = Yellow U= Blue N = Green
Design and specifications are subject to change at any time without prior notice.

