

MODENA

User Manual Book

Electric Storage Water Heater

Quadra Series
ES 10IS, ES 15IS

TABLE OF CONTENT

Part 1: Important Safety Information	3
Special Caution	3
Part 2: Product Introduction	5
Part 3: Installation	5
Installation Instruction	5
Plumbing Connection	6
Part 4: How to Use	8
Part 5: Maintenance	9
Part 6: Troubleshooting	10
Part 7: Disposal of Used Product	11
Part 8: Specification	12
Appendix: Wiring Diagram	12

This manual book explains everything you need to know about your new product. Please contact our Customer Care should you need further assistance through www.modena.com.

PART 1: IMPORTANT SAFETY INFORMATION

Before installing this electric storage water heater, check and ensure that the power socket is reliably grounded. Otherwise, this water heater cannot be installed and used yet. Do not use the extension cord if the power socket is damaged. Incorrect installation and use of this water heater may result in serious injuries and loss of property.

Special Caution

- This appliance (water heater) is not intended to be used by persons with special needs for their physical, sensory or mental capabilities, or lack of experience and knowledge (including children), unless they have been given the supervision or instructions concerning the use of the appliance by a person who responsible for their safety. Children should be supervised to ensure that they are not playing with this water heater.
- The wall in which this water heater is installed should be able to bear the twice bigger load than the weight of this water heater filled fully with water without distortion and cracks. Otherwise, other strengthening measures should be adopted.
- The power socket must be earthed (grounded) reliably. The installation height of the power socket should not be lower than 1.8 m. The rated current of the socket should not be lower than 16A.
- The power socket and the power plug should be kept dry to prevent electrical leakage. If the flexible power cord is damaged, a special power cord that is provided by manufacturer must be selected, and replaced by professional maintenance personnel. Contact MODENA Customer Care for help.
- For the correct operation of the appliance, it is necessary to pay attention that the maximum inlet water pressure is 0.75 MPa, and the minimum inlet water pressure is 0.1 MPa
- When using the water heater for the first time (or for the first use after maintenance), the water heater cannot be switched on until it has been filled fully with water. When filling the water, at least one of the outlet valves of the water heater must be opened to exhaust the air. This valve can be closed after the water heater has been filled fully with water.
- The pressure relief valve that attached with the water heater must be installed at the cold water inlet of this water heater, and make sure it is not

exposed to the vapor. The water may be out-flowed from the pressure relief valve, so the outlet pipe must be opened wide towards the air. In order to drain away the water inside the tank (inner container), open up the pressure relief valve. Twist off the thread screw of the pressure relief valve, and lift the drain handle upwards (see picture 1). The drainage pipe that connected to the pressure relief hole must be kept sloping downwards and placed in a frost-free environment. The water may drip from the discharge pipe of the pressure relief valve; therefore, this pipe must be left open to the air (atmosphere).

- During the heating process, there may be drops of water dripping from the pressure relief hole of the pressure relief valve, and this is a normal case. The pressure relief hole shall not be blocked under any circumstances; otherwise, the water heater may get damaged or even resulting on accidents. If there is a large amount of water leak, please contact MODENA Customer Care for repair.
- The pressure relief valve needs to be checked and cleaned regularly, to make sure it will not be blocked.
- Since the water temperature inside the water heater can reach up to 75 °C, the hot water must not be exposed to human bodies when it is initially used. Adjust the water temperature suitably to the endurance of human skin to avoid scalding.
- If any parts and components of this water heater are damaged please contact MODENA Customer Care for repair.

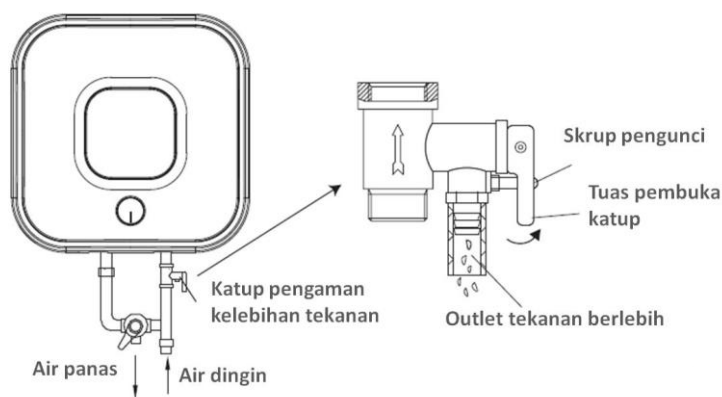

PART 2: PRODUCT INTRODUCTION

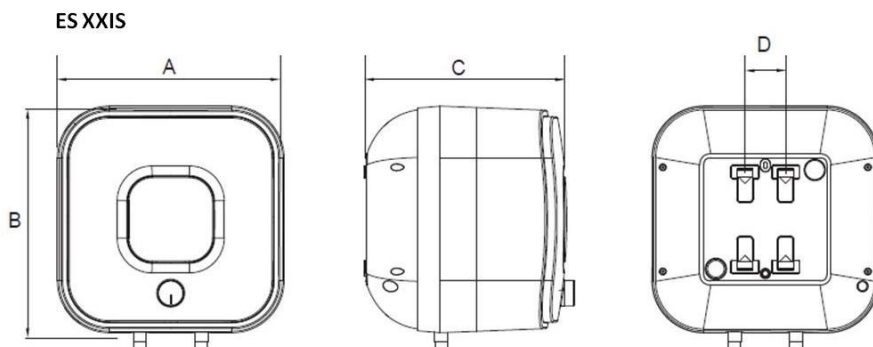

	ES 10IS	ES 15IS
A	324 mm	368 mm
B	324 mm	368 mm
C	315 mm	340 mm
D	66 mm	66 mm

PART 3: INSTALLATION

Installation Instruction

- This water heater should be installed on a solid wall. If the strength of the wall cannot bear the load equal to twice bigger of the total weight of the water heater filled fully with water, it is then necessary to install a special support. In case of the hollow bricks wall, ensure to fill the wall with concrete cement completely, and use anchor fastener bolt (expansion bolt) in case of the hebel wall.
- After selecting a proper location, determine the position of two holes that are used for the installation of the expansion bolts with hook. Make two holes on the wall by using a chopping bit with the depth matching to the size

of the expansion bolts that attached with the water heater. Then, insert the bolts, turn the hook upwards, tighten the nuts to fix firmly, and then hang the water heater on it.

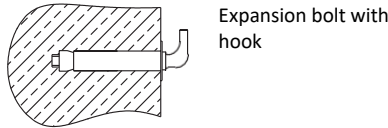

- Install the power socket in the wall. The requirements for the power socket are as follows: 250V/10A, single phase, and three electrodes. It is recommended to place the power socket on the top right of the water heater. The height of the socket to the ground shall not be less than 1.8 m.

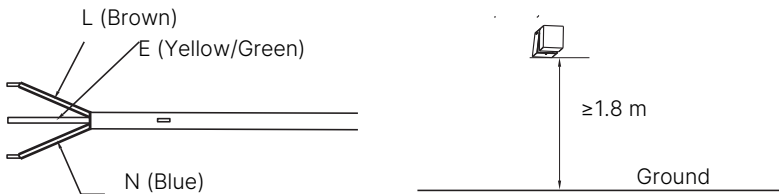

- If the bathroom is too small, the water heater can be installed at another place outside the bathroom. However, to reduce the heat loss caused by long pipeline, the installation position should be as near as possible to the bathroom.

Plumbing Connection

- The dimension of inlet and outlet water pipe is G1/2.
- Connect the pressure relief valve with the inlet water of the water heater.

- To avoid the leakage when connecting the pipelines, the provided rubber seal must be installed by the end of the threads to ensure the connections are leak proof.

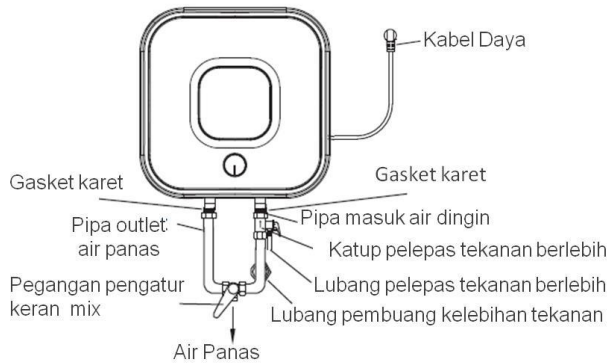

- If the user wants to make a multi-ways supply system, refer to the method shown in figure below for connection of the plumbing.

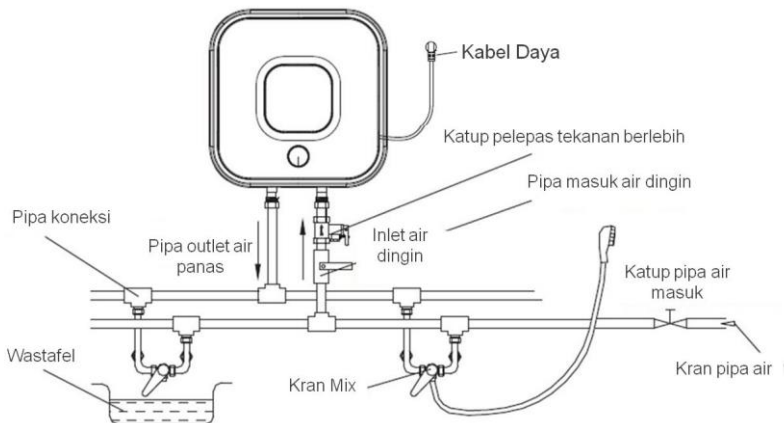

PART 4: HOW TO USE

- First, open the outlet valve, and then open the inlet valve. The water heater gets filled with the water. When the water flows out of the outlet pipe, it implies that the water heater has been filled fully with water. Then, closes the outlet valve.
- Insert the power plug into the power socket.
- If the indicator lamp lights up, the thermostat will automatically control the temperature. When the water temperature inside the heating tank has reached the set temperature, the water heater will switch off automatically. If the water temperature falls below the set point, the water heater will turn on automatically to restore the default temperature.

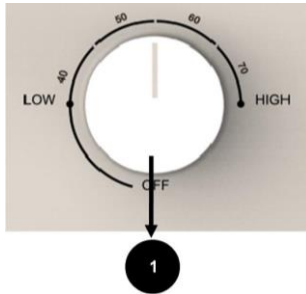

- Rotate the knob according to the knob marker to increase or decrease the temperature.
- In a power-on state, the water heater is heating when the indicator light turns blue. The indicator light will turn off when the heating process is finished, and the water heater is in the insulating state.

PART 5: MAINTENANCE

WARNING!

Do cut off the power supply before maintenance to avoid danger like electric shock.

- Check the power plug and the power socket as often as possible. Electrical/power socket must be secured, and proper grounding must be provided. The power plug and the power socket must not heat excessively.
- If the water heater is not used for a long time, especially in the area with low air temperature (below 0 °C), it is necessary to drain the water from the heater to prevent damage, due to water-freezing in its internal tank (refer to the “Cautions” chapter in this manual book for the method of draining away the water from the inner container/tank).
- To make the water heater durable, it is recommended to regularly clean the internal tank and remove deposits on the electric heating element of the water heater, as well as check the condition of the magnesium anode (whether fully decomposed or not) and, if necessary, replace it with a new one in case of full decomposition. Tank cleaning frequency depends on the hardness of the water in each location where this water heater is applied. Cleaning must be performed by MODENA or special maintenance services. Contact MODENA Customer Care if necessary.
- The water heater is equipped with a thermal switch, which cuts off the power supply of the heating element upon overheating water or the absence of water in the water heater. If the water heater is connected to the power supply (electricity), but the water is not heated and the indicator does not light up, then the thermal switch was off or not switched on. To reset the water heater to the normal operating condition, it is necessary to:
 1. De-energize the water heater; remove the plate of the side/lower cover.
 2. Press the button that is located at the center of the thermal switch.
 3. If the button is not pressed and there is no clicking, then you should wait until the thermal switch cools down to the initial temperature.

Manual Reset Button

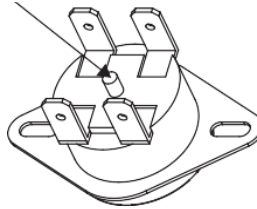

WARNING!

Non-professionals are not allowed to disassemble the thermal switch to do reset. Please contact professionals of MODENA to maintain this water heater. Otherwise, MODENA will not take responsibility of any accidents.

PART 6: TROUBLESHOOTING

Problem	Possible Cause	Recommended Actions
Heating indicator light is off.	Failure of the temperature controller.	Contact MODENA Customer Care for repair.
No water coming out from the hot water outlet.	<ol style="list-style-type: none">1. The inlet water is cut off.2. The water pressure is too low.3. The inlet water valve is not open.	<ol style="list-style-type: none">1. Wait for the water supply to be restored.2. Use the water heater again when the water pressure is increased.3. Open the water inlet valve of running water supply.
Water Temperature is over-high.	Failure of the temperature control system.	Contact MODENA Customer Care for repair
Water leak.	Problem on the seal of each pipe joints (connection).	Seal up the joints.

PART 7: DISPOSAL OF USED PRODUCT



This symbol on the product, or in its packaging, indicates that this product may not be treated as household waste. Instead, it should be taken to the appropriate waste collection point for the recycling of electrical and electronic equipment. By ensuring this product is disposed of correctly, you will help preventing the potential negative consequences for the environment and human health, that otherwise could be caused by the inappropriate waste handling of this product. For more detailed information about the recycling of this product, please contact your local council or your household waste disposal service.

PART 8: SPECIFICATIONS

Model	ES 10 CS1	ES 15 CS1	ES 30 CS1
Product Type	Electric Storage Water Heater	Electric Storage Water Heater	Electric Storage Water Heater
Capacity	10 L	15 L	30 L
Power	200 W	350 W	350 W
Voltage	220-240 V/ 50 Hz	220-240 V/ 50 Hz	220-240 V/ 50Hz
Working Pressure	0.1 – 0.75 MPa	0.1 – 0.75 MPa	0.1 – 0.75 MPa
Temperature Range	30 – 65 °C	30 – 75 °C	30 – 75 °C
Heating Tank	Titanium Porcelain Enamel	Titanium Porcelain Enamel	Titanium Porcelain Enamel
Heating Indicator	Yes	Yes	Yes
Overheat Protection	Yes	Yes	Yes
ELCB	Yes	Yes	Yes
Magnesium Anode	Yes	Yes	Yes
Waterproof Grade	IPX4	IPX4	IPX4
Type of Installation	Vertical	Vertical	Vertical
Dimension	324 x 324 x 315 mm	368 x 368 x 340 mm	440 x 440 x 420 mm
Net Weight	7.5 kg	9.6 kg	13.0 kg

Specifications of this appliance may change without notice to improve the quality of the product. Pictures in this manual are schematic and may not match your product exactly. Values stated on the machine labels or in the documentation accompanying it are obtained in laboratory in accordance with the relevant standards. Depending on operational and environmental conditions of the appliance, values may vary.

APPENDIX: WIRING DIAGRAM

