

MODENA

User Manual Book

Air Purifier

Purificato Series
AP 2531

TABLE OF CONTENT

Part 1: Important Safety Information	3
General Cautions	3
Prohibitions	3
Warnings	4
Notices	4
Part 2: Product Introduction	5
Product Components	5
Control Panel and Display	5
Part 3: How to Use	6
Panel and Display Instruction	6
Air Quality Indicator	6
Part 4: Maintenance	7
Part 5: Troubleshooting	8
Part 6: Specification	9
Appendix: Wiring Diagram	10

This manual book explains everything you need to know about your new product. Please contact our Customer Care should you need further assistance through www.modena.com.

PART 1: IMPORTANT SAFETY INFORMATION

General Cautions

1. Please check whether the device is fine and the components are complete after unboxing the package.
2. Please be sure to remove the plastic package of the filter before first time using the device.
3. Children and incapacitated person should use the device accompanied by their superintendent.
4. Please unplug the device immediately if accident occurs, and do not use the machine under defect condition.
5. In order to avoid danger, if the supply cord is damaged, it can only be change by manufacturer or the qualified maintenance person.
6. Please do not use other components that are not permitted by manufacturer, otherwise warranty will be terminated if the device is breakdown in that case.

Prohibitions

1. Do not put your hand and foreign matter into the air inlet and air outlet.
2. Do not unplug the power with wet hands.
3. Do not use the device at the place where full of hydrogen, natural gas, dimethylmethane, and other flammable gas.
4. Do not use the device if power cord or plug is damaged, or power socket slacked off.
5. Do not jam the air inlet and air outlet
6. Do not use the device when using the aerosol bomb or there are oil residue, incense smoke, alight flame, and chemical odor in the room. And also do not use the device in deep wet place such as shower room.
7. Do not operate the device without filter inside.
8. Do not wash or re-use the composite filter.

Warnings

1. Only 220V voltage socket can be used.
2. Hold still the plug when unplug it, and do not pull the power cord, otherwise it will cause electric shock or sparks.
3. Unplug the device when not in use or need cleaning.
4. Clean the dust on the plug regularly.
5. Do not use strong causticity detergent when cleaning the device because it can damage its surface.
6. Use only soft cloth to clean the surface of the device, otherwise it will be damaged, scratched, or even fractured.
7. Do not put the device close to the heat source or even put onto it.
8. Ethyl alcohol or organic solvent are forbidden to be used to wipe the device, otherwise it will damage the device or cause electric shock and fire sparks.

Notices

1. User can directly push the device or hands hold on both sides of the buckle to move it. If user hold the air outlet, it is possible to make the air outlet or the host device fall off, which can cause injury.
2. This device is not intended to be used by persons with special needs for their physical, sensory or mental capabilities, or lack of experience and knowledge (including children), unless they have been given the supervision or instructions concerning the use of the appliance by a person who responsible for their safety. Children should be supervised to ensure that they are not playing with this water heater.
3. If the device causing signal interference on the radio or television, please follow one or more below instructions:
 - Re-adjust or rotate the receiving antenna.
 - Take the device far away from radio or television receiving antenna.
 - Connect the air purifier power and signal power on different socket.
 - Please contact MODENA Service Center or qualified technician if assistance is needed.





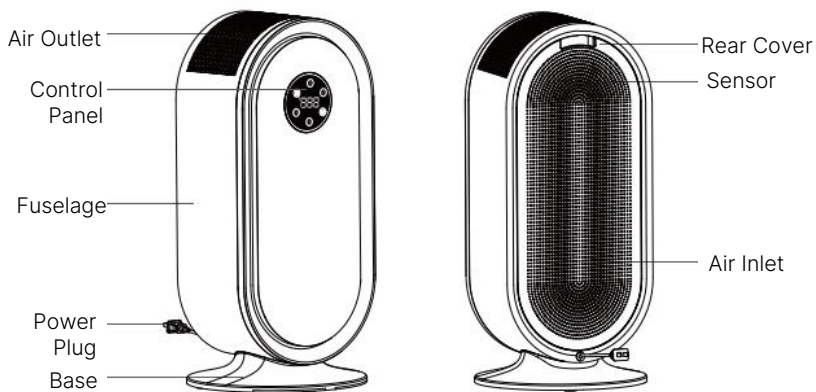

PART 2: PRODUCT INTRODUCTION

Product Components









Control Panel and Display



	Power Button		Fan Speed Adjustment
	Ion Function		Auto Function
	Filter Indicator / Reset		Timer and Child Lock

PART 3: HOW TO USE

Button Instructions

	Turn the device on or off. When the device is turning on, it will triggers the air quality detection system to open and the digital display will flash for about 30 seconds. Once the air quality detection test is completed, the air quality condition is informed by the digital display as well as the air quality indicator lamp.
	Select the speed of the wind. 1 for low, 2 for medium, 3 for high speed, and 4 for sleep mode.
	Activate the intelligent mode. If this fuction is activated, the device will automatically adjust the wind speed based on the air quality detected by the sensor.
	These button has two functions. Quick tap this button to set the timer. 1 tap for 1 hour, 2 taps for 2 hours, and so on. Time can be set until 8 hours. To activate the child lock function, long press on the button for about 3 seconds. This button indicator will turn on, and other buttons are not functional. Long press the this button again for 3 seconds to unlock it, indicator light will be off and all the buttons is back to functional again.
	Activate the anion function. Tap the button once to activate and tap once again to deactivate it. Anions electrically neutralize and remove bacteria, dust, pollen, mold, and contaminated particulates which are freely float and make foul air.
	If the filter button flashing in red, it means that the filter can be used only for next 48 hours and user need to change the filter. To reset the filter, long press the filter button until the red light stop flashing.

Air Quality Indicator

Air Quality Status	Excellent	Good	Poor
Indicator Light Color	Green	Blue	Red
Air Quality Value	1 – 75 µg/m3	75 – 150 µg/m3	> 150 µg/m3
Wind Speed	Gear 1 / low	Gear 2 / med	Gear 3 / high

PART 4: MAINTENANCE

Warning: The device must be unplugged before maintenance and cleaning

Device Cleaning

1. Wipe stains with soft cloth.
2. For stubborn stains, dip some neutral liquid into the soft cloth then clean.

Note: No hard object to scratch the device surface during maintenance and cleaning. When tear down the device, please refer to the instruction manual and do as the requirement to avoid damaging the components.

Filter Cleaning and Replacement

1. Built-in program will remind to replace the filter. Due to different air quality around, filter lifetime will also be different. Filter replacement also can be judged from the device noise and smell.
2. If there is dust cover on the composite filter, a vacuum cleaner can be used to clean the dust on its surface to extend filter lifetime.

Notes:

- Filter lifetime can shorten if being used for certain condition, such as in a room where many people smoke. Please replace the filter when purify effect is not good anymore.
- Please dispose the used filter as non-combustible garbage.

Filter Replacement Method

1. Power off the device and unplug the power plug. (Pic. 1)
2. Open the rear cover from the buckle. (Pic 2).
3. Take out the old filter. (Pic 3)
4. Remove the plastic packaging from the new filter. (Pic 4).
5. Insert the new filter into the device. (Pic 5).
6. Put the rear cover back to its original position. (Pic 6).

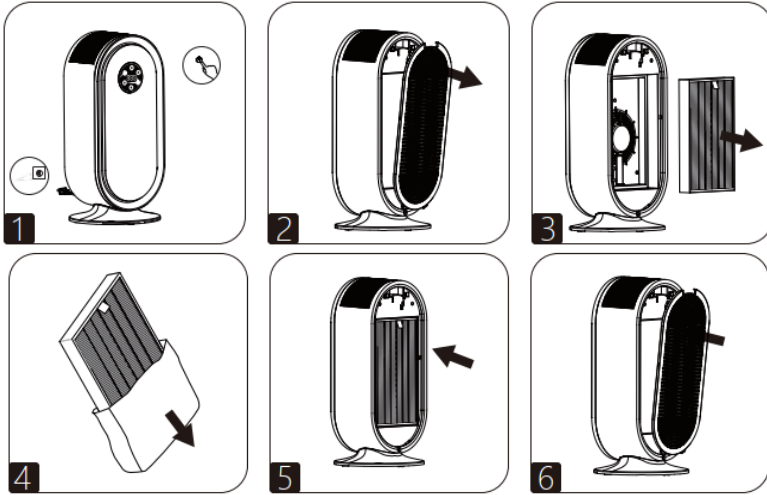

PART 5: TROUBLESHOOTING

Problem	Possible Cause	Recommended Actions
The device cannot be turned on	The device does not plug well.	Check the power plug and re-plug it properly
The air flow is weak	<ol style="list-style-type: none"> 1. Filter package has not been removed. 2. Foreign materials jam the air inlet or outlet. 3. The filter is dirty. 	<ol style="list-style-type: none"> 1. Remove the plastic package of the filter. 2. Clean foreign material at the air inlet or outlet. 3. Clean or replace the filter.
Dust removal effect is not obvious and air quality does not get better	<ol style="list-style-type: none"> 1. No filter in the device. 2. Door or window of the room open frequently. 3. The device is put in narrow place or close to barrier around. 4. The filter is dirty. 	<ol style="list-style-type: none"> 1. Install filter into the device. 2. Reduce the door or window opening frequency. 3. Move device to wider place without any barrier. 4. Clean or replace the filter.
Odor comes from the air outlet	<ol style="list-style-type: none"> 1. Many people smoke or do something causing odor in the room. 2. The filter is dirty. 	<ol style="list-style-type: none"> 1. Change the indoor air. 2. Clean or replace the filter.

PART 6: SPECIFICATIONS

Model	AP 2531
Product Type	Room Air Purifier
Color	White
Control Panel	Touch Control
Filter Composition	Pre-Filter, Activated Carbon, Anti-Bacteria Cloth, HEPA13
WIFI Function	No
Negative Anion Function	Yes
Fan Speed	Low / Mid / High
Display	Yes
Timer Setting	Yes, 1-8 hours
Air Quality Indicator	Yes, Green-Blue-Red
Sleep Mode	Yes
Auto Mode	Yes
Light Sensor	No
Filter Replacement Indicator	Yes
Child Lock	Yes
Rated Voltage	220 V/ 60 Hz
Power	50 W
Clean Air Delivery Rate	260 m3/h
Coverage Area	25 m2
Dimension	294.5 x 294.5 x 606 mm

Specifications of this appliance may change without notice to improve the quality of the product. Pictures in this manual are schematic and may not match your product exactly. Values stated on the machine labels or in the documentation accompanying it are obtained in laboratory in accordance with the relevant standards. Depending on operational and environmental conditions of the appliance, values may vary.

APPENDIX: WIRING DIAGRAM

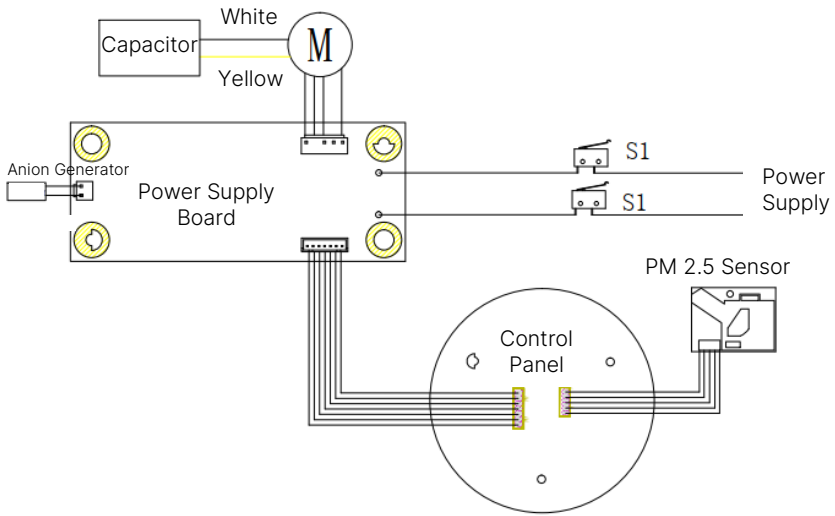

NOTE :

MODENA