

User Manual Book Built-in Refrigerator

Raffinato Series
RF 2930 W

MODENA

Thank you for your trust in choosing MODENA products for your household needs. With your satisfaction as our priority, we constantly aim to deliver stylishly designed products equipped with state-of-the-art technology to assist you in your daily activities.





This is your guidebook containing everything you need to know about our product. Please reach out to us if you need further assistance or other information via our Customer Care or our official website www.modena.com.







TABLE OF CONTENT

Part 1: Safety information	4
Part 2: Name of parts	7
Part 3: Installation guide	8
Before first use	8
Moving the appliance	8
Installation environment	8
Feet adjustment	9
Part 4: How to use	10
Door Alarm	11
Accessories	11
First use	12
Daily use	12
Food storage tips	13
Part 5: Maintenance	17
Defrosting	17
LED lamp replacement	18
Environmental notice	18
Part 6: Troubleshooting	19
Part 7: Specification	21
Appendix 1: Built-in Installation Guide	22
Appendix 2: Food storage guide	34

PART 1: SAFETY INFORMATION

READ THIS MANUAL CAREFULLY!

Symbol	Type	Definition
	WARNING	Serious injury or death risk
	RISK OF ELECTRIC SHOCK	Dangerous voltage risk
	FIRE HAZARD	Risk of fire or flammable material
	CAUTION	Injury or property damage risk
	IMPORTANT	Important information on product operations

-  Keep the air ventilation open, if the appliance is set in enclosed space or in the built-in structure and clear from any obstructions.
-  Do not use electrical devices inside the food storage compartments of the appliance, unless they are of the type recommended by the manufacturer.
-  Do not use electrical appliances inside the food storage compartments of the appliance, unless they are of the type recommended by the manufacturer.
-  Do not damage the refrigerant circuit.
-  When positioning the appliance, ensure the supply cord is not trapped or damaged.
-  The refrigerant and insulation blowing agent inside the

refrigerator need a special disposal procedure. Consult the disposal method with related parties.



Your refrigerator contains iso-butane refrigerant (R600a) in a small quantity. Make sure there is no damage or leakage. Refrigerant leakage may lead to fire or damage to your eyes. If a leakage is detected, move the refrigerator away from the fire sources or any other potential sources which can cause fire.



WARNING! Do not place multiple portable socket or portable power supplies on the back of the appliance

- Do not use power socket adapter
- For products using Fixing Bracket



WARNING! To avoid a danger due to instability of the appliance, it must be fixed in accordance with the instructions.

- Opening the door for a long period of time can cause a significant increase of the temperature in the compartment of the appliance
- Clean the surfaces that contact with food directly and also the accessible drainage systems regularly
- Store raw meat and fish in suitable containers in the refrigerator, so that they do not contact with or drip onto other foods.
- If the refrigerating appliance is left empty for a long period of time; switch it off, defrost, clean, dry, and leave the door open to prevent mold from developing within the appliance
- While carrying and placing the refrigerator, do not damage the cooler gas circuit.

- Do not store explosive substances such as aerosol cans with a flammable propellant in this appliance.
- This appliance is intended to be used in household and domestic applications
- If the socket does not match the refrigerator plug, it must be replaced by the manufacturer, a service agent or similar qualified persons in order to avoid accidents.
- A specially grounded plug has been connected to the power cord of your refrigerator. This plug should be used with a specially grounded power socket of 16 amperes. If there is no such socket available in your house, please have one installed by an expert authorized electrician.
- Children are not allowed to perform cleaning or user maintenance of the appliance, very young children (0-3 years old) are not allowed to use appliances, young children (3-8 years old) are allowed to use appliances under surveillance, older children (8-14 years old) and vulnerable people can use appliances safely after they have been given appropriate surveillance or instruction concerning the use of the appliance and the risks that may occur. Very vulnerable people are not allowed to use appliances unless continuous surveillance is given.
- If the supply cord is damaged, it must be replaced by a technician an authorized service agent or similar qualified persons, in order to avoid danger.
- This appliance is not intended for use at altitudes higher than 2000 meters above the sea level.

PART 2: NAME OF PARTS

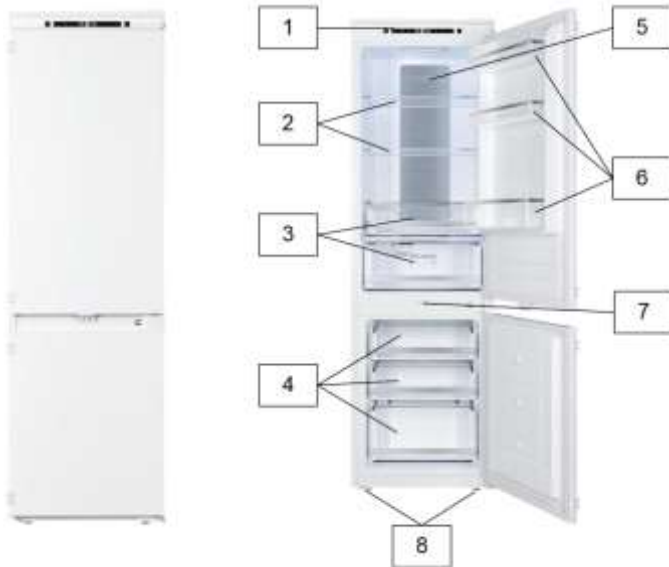

1. Control panel
2. Refrigerator glass shelves& Wine Rack
3. Crisper drawers
4. Freezer drawers
5. Multiflow air duct
6. Door Baskets
7. Magnetic door switch
8. Adjustable feet

**Feature and parts may vary depending on the model*

PART 3: INSTALLATION GUIDE

Before First Use

- Remove all packages, including the foam backing at the bottom of refrigerator and the tapes fixing accessories in the box.
- Place the refrigerator to a proper position, and adjust the feet to level. It is better to clean the refrigerator before use.

Moving the Appliance

- Do not carry the refrigerator horizontally or reversely
- Do not carry the refrigerator by holding the door or handle; the refrigerator shall be carried by lifting the bottom.

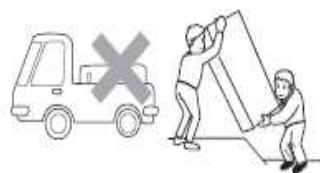

Installation Environment

- Keep away from heat sources or direct sunlight
- The refrigerator must be placed on a hard and flat ground
- The refrigerator shall be kept away from damp locations where water is easy to splash; water or dirt shall be removed with soft cloth timely to prevent rusting which may have an effect on the electrical characteristics.
- Place the refrigerator in a well-ventilated place, reserve a certain space around and behind the refrigerator, and do not cover or block the air grille on the rear cover plate of compressor at the back of refrigerator
- Provide space of minimum 100 mm between the back of the refrigerator with the wall, and minimum 50 mm between both sides of the refrigerator with the wall or other objects

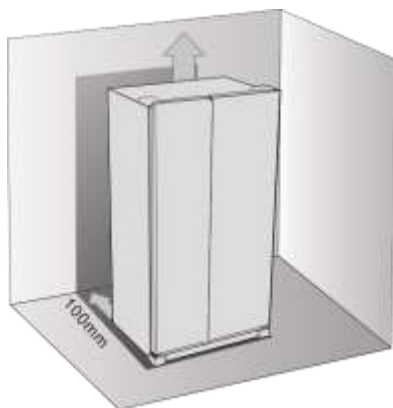

Feet Adjustment

- Please make sure to adjust two front plastic feet until the height is suitable
- Turn the feet clockwise to heighten them or rotate the feet counterclockwise to lower them until the desired height.

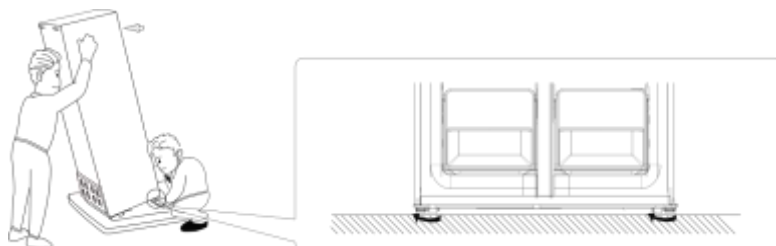

PART 4: HOW TO USE

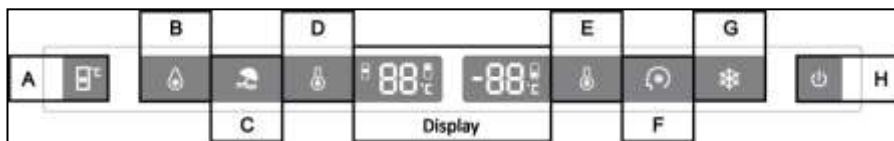

Button	Function
A	<p>Fresh Zone Temperature Adjustment</p> <p>Press this button to temporarily turn on the display section corresponding to the fresh zone, press the button again to adjust the temperature, ranging from -2°C to 3°C</p>
B	<p>Fast Cooling</p> <p>Press this button until light of button illuminates. When Fast cooling is turned on, the whole appliance starts to work automatically at settings: 2°C and quits after 2.5 hours and the light will turn off</p>
C	<p>Holiday Mode</p> <p>Press this button until light of button illuminates. When Holiday Mode is turned on, the whole appliance starts to work automatically at settings: fridge at 17°C and freezer at -18°C. Fresh zone works at 17°C.</p>
D	<p>Fridge Temperature Adjustment</p> <p>Press this button to adjust the temperature, ranging from 2°C to 8°C</p>
E	<p>Freezer Temperature Adjustment</p> <p>Press this button to adjust the temperature, ranging from -15°C to -25°C</p>
F	<p>Smart Mode</p> <p>Press this button until light of button illuminates. When Smart Mode is turned on, the whole appliance starts to work automatically at settings: fridge at 5°C and freezer at -18°C. Fresh zone works at 0°C.</p>

Button	Function
G	Fast Freezing Press this button until light of button illuminates. When Fast freezing is turned on, the whole appliance starts to work automatically at settings: -25°C and quits after 6 hours and the light will turn off
H	Power On/Off Press this button for 3 seconds to switch on or off your appliance

- When turning the appliance on for the first time or after power failure, the appliance will always works at settings: 5°C for fridge, 0°C for Fresh zone and -18°C for freezer. If you want to adjust the temperature or functions manually, press the adjustment button on the control panel
- On the No Frost models, there is an additional function: Forced Defrosting. Press the buttons D/E + H for 5 seconds to switch on the Forced Defrosting function to clean the freezer evaporator and digital display of freezer temperature shine. Press the button D/E + H for 3 seconds to switch off the Force Defrosting function, and the digital display of freezer temperature will turn off.

Door Alarm

If the refrigerator door is opened more than 2 minutes, there will be beep sounds.

Accessories

Movable Shelf

Your appliance is equipped with movable shelves. The wall of refrigerator is equipped with a series of runners so the shelves can be positioned as desired

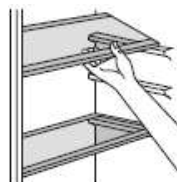

Door Basket

To ease storage of food packages of various sizes, the door shelves can be placed at different heights. To make these adjustments proceed as follows: gradually pull the shelf in the direction of arrows until it comes free, then re-position as required.



First use

Cleaning the interior

Before using the appliance for the first time, wash the interior and all internal accessories with lukewarm water and some neutral soap so as to remove the typical smell of a brand new product, then dry thoroughly.

IMPORTANT!

Do not use detergents or abrasive powders, as these will damage the finish.

Daily Use

Freezing Fresh Food

- The freezer compartment is suitable for freezing fresh food and storing frozen and deep-frozen food for a long time.
- Place the fresh food to be frozen in the bottom compartment.
- The maximum amount of food that can be frozen in 24 hours is specified on the rating plate.
- The freezing process lasts 24 hours: during this period do not add other food to be frozen.

Storing Frozen Food

When first starting-up or after a period out of use. Before putting the product in the compartment let the appliance run at least 2 hours on the higher settings.

IMPORTANT!

In the event of accidental defrosting, for example the power has been off for longer than the value shown in the technical characteristics chart under “rising time”, the defrosted food must be consumed quickly or cooked immediately and then re-frozen (after cooked).

Thawing

Deep-frozen or frozen food, prior to be used, can be thawed in the freezer compartment or at room temperature, depending on the time available for this operation. Small pieces may even be cooked still frozen, directly from the freezer. In this case, cooking will take longer.

Food Storage Tips

Refrigerator

- To reduce humidity and avoid the consequent formation of frost, always store liquids in sealed containers in the refrigerator. Frost tends to concentrate in the coldest parts of the evaporating liquid and, in time, your appliance will require more frequent defrosting.
- Never place warm food in the refrigerator. Warm food should be allowed to cool at room temperature and should be arranged to ensure adequate air circulation in the refrigerator compartment.
- Make sure no items are in direct contact with the rear wall of the appliance as frost will develop and packaging will stick to it. Do not open the refrigerator door frequently.
- We recommend that meat and clean fish are loosely wrapped and stored on the glass shelf just above the vegetable bin where the air is cooler, as this provides the best storage conditions.
- Store loose fruit and vegetable items in the crisper containers. Storing fruit and vegetables separately helps prevent ethylene-sensitive vegetables (green leaves, broccoli, carrot, etc.) being affected by ethylene releasing fruits (banana, peach, apricot, fig etc.).
- Do not put wet vegetables into the refrigerator.

- Storage time for all food products depends on the initial quality of the food and an uninterrupted refrigeration cycle before refrigerator storage.
- To avoid cross-contamination do not store meat products with fruit and vegetables. Water leaking from meat may contaminate other products in the refrigerator. You should package meat products and clean any leakages on the shelves.
- Do not put food in front of the air flow passage.
- Consume packaged foods before the recommended expiry date.
- See Food Storage Guide in Appendix 2

NOTE!

Potatoes, onions and garlic should not be stored in the refrigerator. The table below is a quick guide to show you the most efficient way to store the major food groups in your refrigerator compartment.

Freezer

- The freezer is used for storing frozen food, freezing fresh food, and making ice cubes
- For freezing fresh food; wrap and seal fresh food properly, that is the packaging should be air tight and shouldn't leak. Special freezer bags, aluminum foil polythene bags and plastic containers are ideal.
- Do not store fresh food next to frozen food as it can thaw the frozen food.
- Before freezing fresh food, divide it into portions that can be consumed in one sitting.
- Consume thawed frozen food within a short period of time after defrosting
- Never place warm food in the freezer compartment as it will thaw the frozen food.

- Always follow the manufacturer's instructions on food packaging when storing frozen food. If no information is provided food, should not be stored for ore than 3 months from the date of purchase.
- When purchasing frozen food, make sure that it has been stored under appropriate conditions and that the packaging is not damaged.
- Frozen food should be transported in appropriate containers and placed in the freezer as soon as possible
- Do not purchase frozen food if the packaging shows signs of humidity and abnormal swelling. It is probable that it has been stored at an unsuitable temperature and that the contents have deteriorated.
- The storage life of frozen food depends on the room temperature, the thermostat setting, how often the door is opened, the type of food, and the length of time required to transport the product from the shop to your home. Always follow the instructions printed on the packaging and never exceed the maximum storage life indicated.
- The maximum amount of fresh food (in kg) that can be frozen in 24 hours is indicated on the appliance label.
- See Food Storage Guide in Appendix 2

NOTE!

If you attempt to open the freezer door immediately after closing it, you will find that it will not open easily. This is normal. Once equilibrium has been reached, the door will open easily.

IMPORTANT!

- Never refreeze thawed frozen food.
- The taste of some spices found in cooked dishes (anise, basilica, watercress, vinegar, assorted spices, ginger, garlic, onion, mustard, thyme, marjoram, black pepper, etc.) changes and they assume a strong taste when they are stored for a long period of time. Therefore, add small amounts of spices to food to be frozen, or the desired spice should be added after the food has thawed.
- The storage time of food is dependent on the type of oil used. Suitable oils are margarine, calf fat, olive oil and butter. Unsuitable oils are peanut oil and pig fat.
- Food in liquid form should be frozen in plastic cups and other food should be frozen in plastic folios or bags.

PART 5: MAINTENANCE



Disconnect the unit from the power supply before cleaning.



Do not wash your appliance by pouring water on it.



Do not use abrasive products, detergents or soaps for cleaning the appliance.

After washing, rinse with clean water and dry carefully. When you have finished cleaning, reconnect the plug to the mains supply with dry hands.

- Make sure that no water enters the lamp housing and other electrical components.
- The appliance should be cleaned regularly using a solution of bicarbonate of soda and lukewarm water.
- Clean the accessories separately by hand with soap and water. Do not wash accessories in a dish washer.
- Clean the condenser with a brush at least twice a year. This will help you to save on energy costs and increase productivity.



The power supply must be disconnected during cleaning!

Defrosting

- Your appliance performs automatic defrosting. The water formed as a result of defrosting passes through the water collection spout, flows into the vaporization container behind your appliance and evaporates there.
- Make sure you have disconnected the plug of your appliance before cleaning the vaporization container.
- Remove the vaporization container from its position by removing the screws as indicated. Clean it with soapy water at specific time intervals. This will prevent odors from forming.

LED Lamp Replacement

If your appliance has LED lighting contact the help desk as this should be changed by technician.

Environmental Notice



The packaging material used is recyclable. We recommend that you separate plastic, paper and cardboard and give them to recycling agents. To help preserve the environment, the refrigerant used in this product is R600a (Hydrofluorocarbon - HFC), which does not affect the ozone layer and has little impact on the greenhouse effect.

According to WEEE (Waste of Electrical and Electronic Equipment) guidelines, waste from electrical and electronic devices should be collected separately. If you need to remove of this appliance in the future, do not throw it away with the rest of your domestic garbage. Instead, please take the appliance to the nearest WEEE collecting agents, where available.

PART 6: TROUBLESHOOTING

Problem	Possible Cause	Recommended Action
Refrigerator does not operate	<ul style="list-style-type: none"> • The mains plug of the appliance is not in the socket properly • The fuse for the domestic supply is switched off 	<ul style="list-style-type: none"> • Check whether the power is on; • The fuse must be switched on.
No display on the display panel	<ul style="list-style-type: none"> • The mains plug of the appliance is not in the socket properly • The fuse for the domestic supply is switched off 	<ul style="list-style-type: none"> • Check whether the power is on; • The fuse must be switched on.
Alarm sound	<ul style="list-style-type: none"> • Door is slightly open or not close more than 1 minute 	<ul style="list-style-type: none"> • Close the door completely.
The food is not frozen enough	<ul style="list-style-type: none"> • Temperature is not properly adjusted • Door was opened for an extended period • A large quantity of warm food was placed in the appliance within the last 24 hours • The appliance is near a heat source 	<ul style="list-style-type: none"> • Please look in the initial temperature setting section • Open the door as long as necessary • Adjust the temperature to colder setting temporarily • Please look in the installation section
The compressor do not work	<ul style="list-style-type: none"> • It is under defrosting mode • Power is not connected well 	<ul style="list-style-type: none"> • It is normal for defrosting • Check whether the power is connected well.
Compressor runs too long	<ul style="list-style-type: none"> • The fridge has recently been dis-connected for a period of time 	<ul style="list-style-type: none"> • It takes some hours for the fridge to cool down completely. • Hot food will cause the fridge to run

Problem	Possible Cause	Recommended Action
	<ul style="list-style-type: none"> • Put too much fresh or hot food • Doors are opened too frequently or too long 	<p>longer until the desired temperature is reached.</p> <ul style="list-style-type: none"> • Warm air entering the fridge cause it to run longer. Open the door less often.
Vibrations	<ul style="list-style-type: none"> • Floor is uneven or weak. Refrigerator rocks on the floor when it is moved slightly. • The refrigerator is touching the wall. 	<ul style="list-style-type: none"> • Check to assure that the refrigerator is on a level surface. • Re-level the refrigerator and move it from the wall

PART 7: SPECIFICATION

Model	RF 2930 W
Type	Built-in Bottom freezer
No. of doors	2
Defrosting	Automatic
Compressor	Inverter
Refrigerant	R600a
Interior light	LED
Total Capacity (Liter)	310
Defrost power input (Watt)	160
Rated Voltage (Volt)	220-240
Rated Frequency (Hz)	50
Product dimension (W×D×H)(mm)	540x550x1776
Product weight (kg)	57

**S = Stainless, R = Red, C = Cream, O = Orange, N = Green, U = Blue, W = White, V = Silver, G = Grey, L = Black*

Design and specification can change without prior notice to improve the quality of the product. The illustration in this manual is schematic and can be different with your actual product. The values on label or in other documents are according to laboratory test and relevant standards. Values can vary depending on the actual operational and environmental condition of the product.

APPENDIX 1: BUILT-IN INSTALLATION GUIDE

About these instructions

- Read and follow the operating and installation instructions carefully
- The manufacturer is not liable if you disregard the instructions and warnings in the operating and installation instructions
- The appliance should be installed by technicians or a professionally qualified person.
- Retain all documents for subsequent use or for the next owner.

Risk of electric shock

- Improper installations and repairs may put the user at considerable risk
- Never use extension cords or multiple plugs
- Never use adapters
- If the power cord is damaged: Immediately disconnect the appliance from the power supply and replace the power cord
- Only use original parts supplied by the manufacturer

Risk of injury

- Risk of tipping over! The appliance is very heavy. The appliance should always be transported and set up by at least 2 people
- Danger of cut injuries! Always wear protective gloves while installing the appliance.

Built-in Cutout Dimension

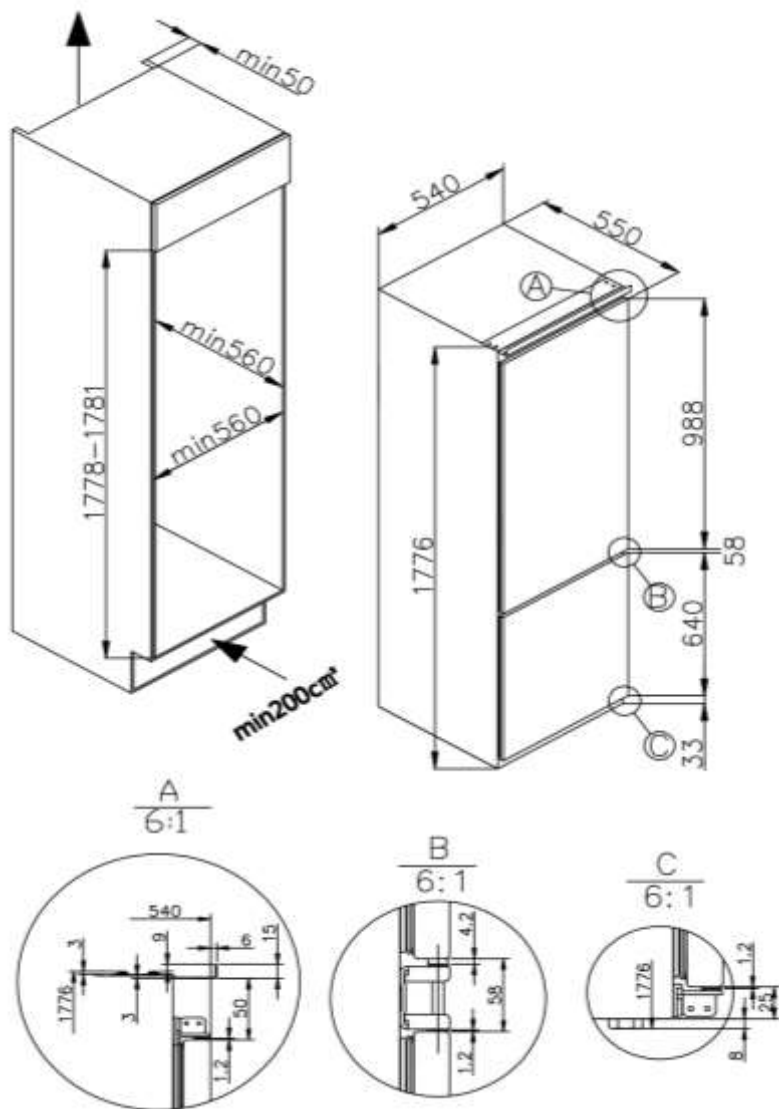

Door Opening Direction

1. Remove the screw caps on the front of the product.

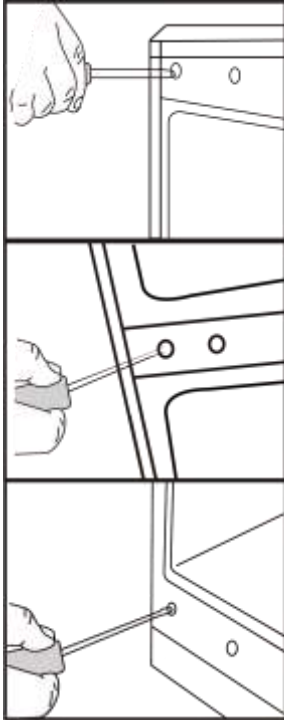

2. With the door closed remove the screws from the top and bottom hinges that hold the appliance door to the hinges. Remove the screws from the top hinge first.

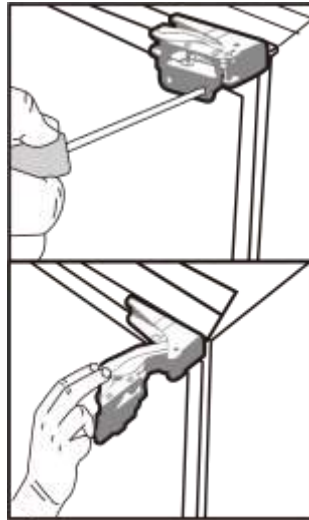

- Support the door at the bottom and open the hinges away from the appliance door. Carefully lift the appliance door away, ensuring you don't damage the hinges or the door.

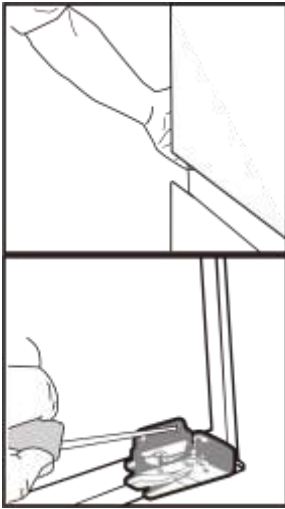

- Use the same way to remove the other doors (if applicable)
- With the top hinge open, remove the screws from the top hinge that fix the hinge to the cabinet of the appliance.

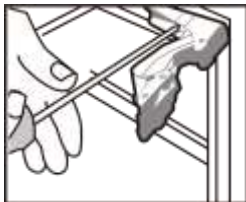

- Flip over the top hinge (by 180°) and fix it in place on the diagonally opposite corner of the appliance cabinet. Reattach the door by fixing the outside screws of the hinge to the door.



- Install all the door(s) correctly.

Ventilation

The main consideration when installing any refrigeration unit into a fitted kitchen is ventilation. The heat removed from the cooling compartment needs to be dissipated into the atmosphere. Incorrect ventilation can lead to premature compressor failure, excessive power consumption, total system failure and may invalidate the warranty provided with the appliance.

Make a 200 cm² opening for the upper ventilation.

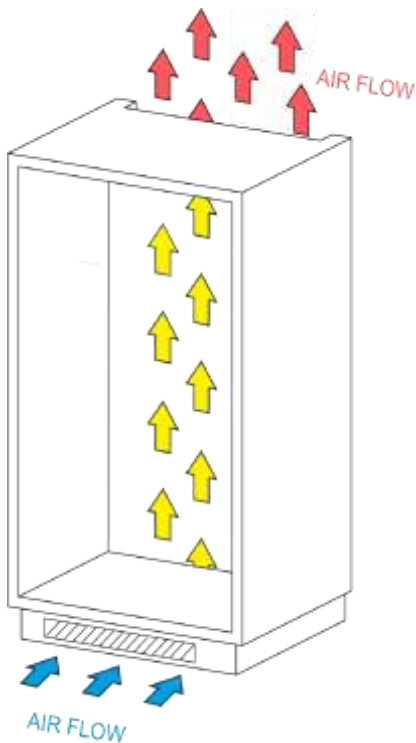

- An air passageway should be provided in the top of the cabinet run to allow free air in and out.
- There should be space at the rear of the cabinet to allow cool air to be drawn over the condenser.
- A cutout should be made in the plinth below the fridge/freezer and can be finished neatly using the air vent grille. Alternatively, a thin section of the plinth can be removed to allow air into the unit (recommended 600mm x 10mm)

Installation

1. Place the product in front of the cabinet and connect the power cord
2. With the help of another person, insert the product into the cabinet
3. Push the product half way into the cabinet and install the shims onto the hinges

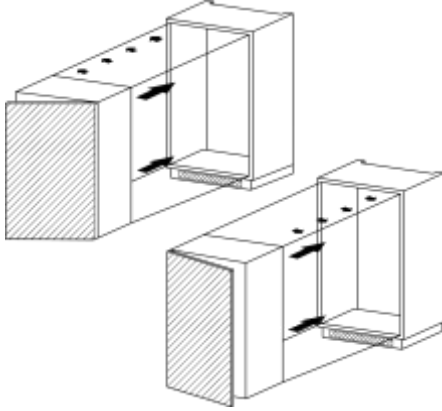

4. Use the provided wrench to adjust the bottom front foot to level the product

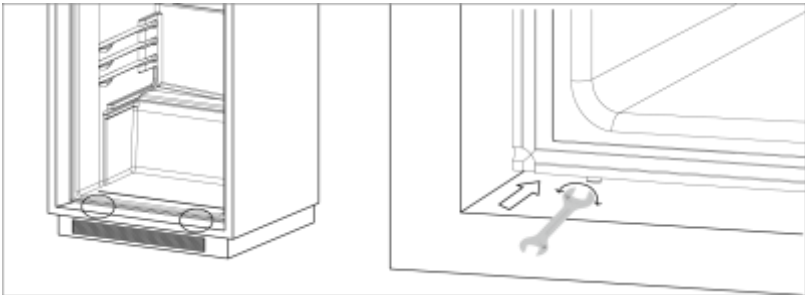

5. There are two metal plates at the base of the product. Fit the supplied white covers to the plates based on the following pictures



Ensure that the lips of the spacers are level with the lip of the cabinet base. The more air that can get in and out of the product, the better and more efficient the product performance will be.

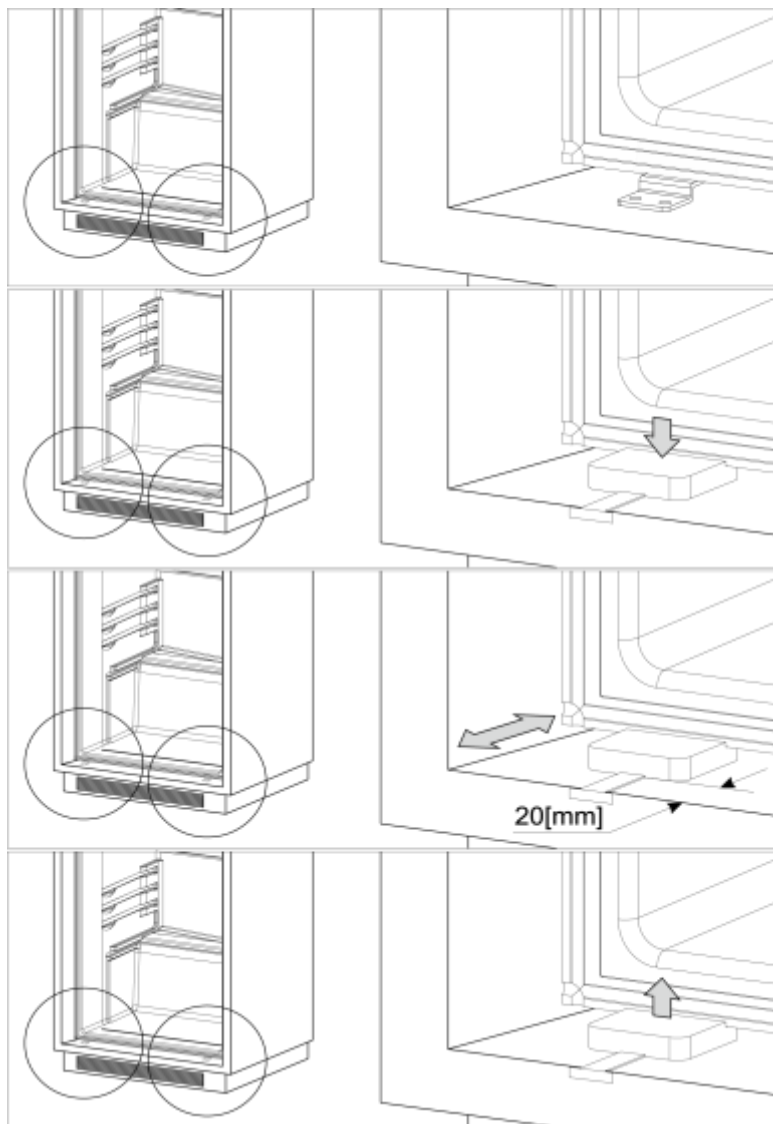

6. After fitting the white cover and spacers, fix the lower plate with screws and install the white covers

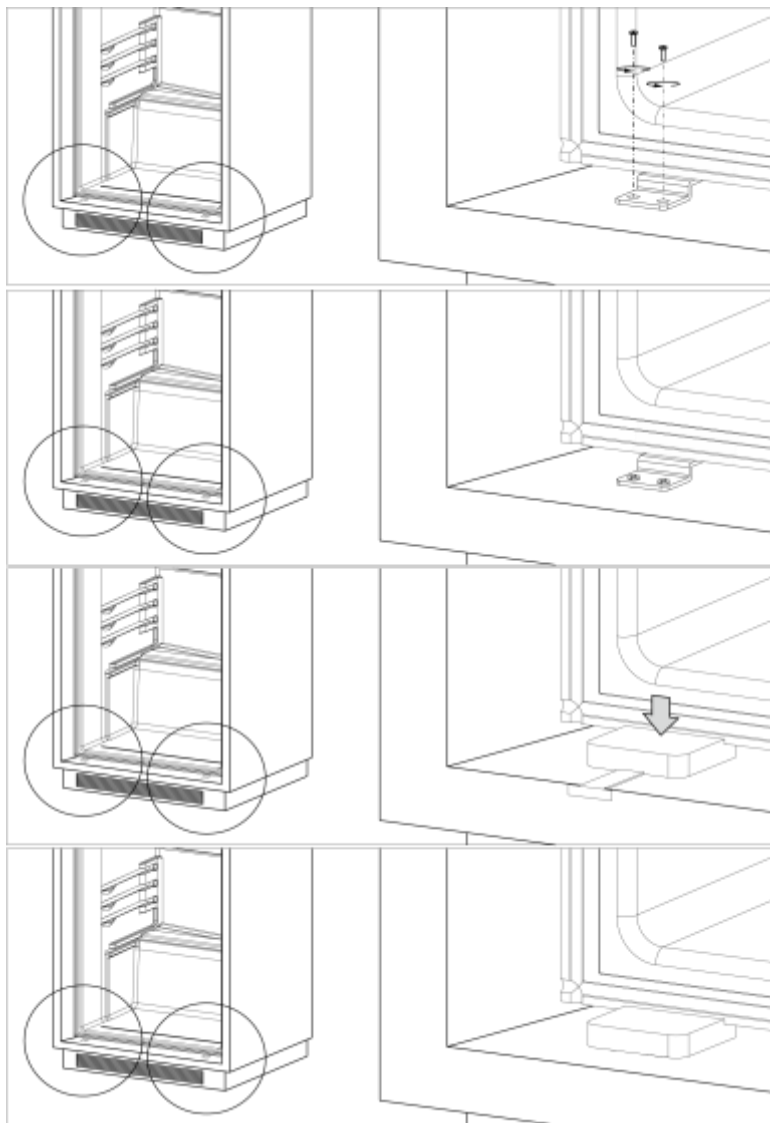

7. Fix the upper plate and install the screw cover as follows

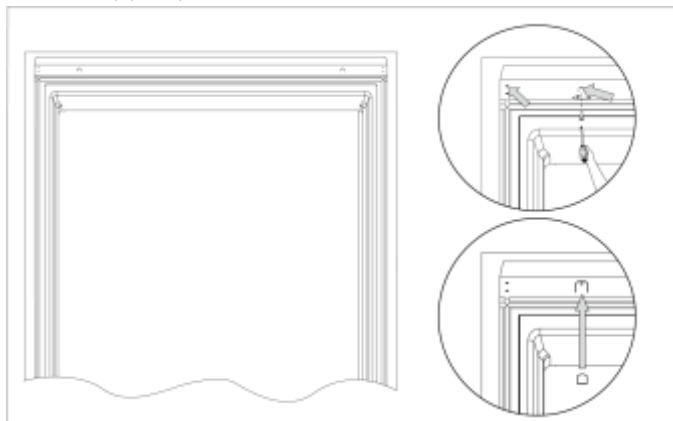

8. Fix the hinges onto the cabinet side plates

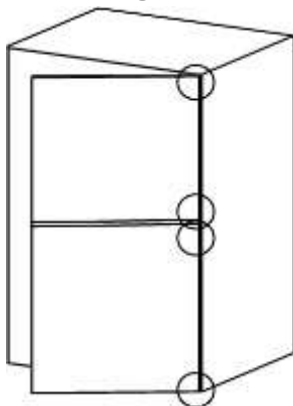

9. Use the strip to fill up the space between the cabinet and side of the product

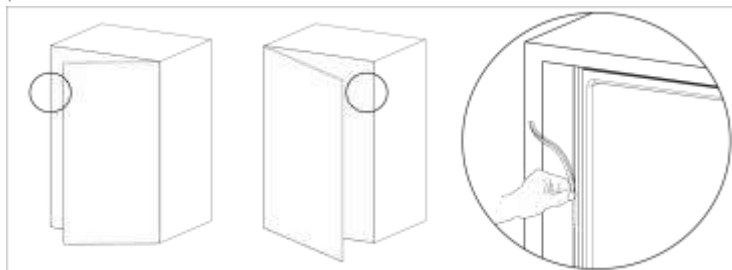

Mounting the Fascia Doors

Remove the white decorative cover (Fig. 1) by lifting it upwards.

Fig.1



Obtain the below measurements:
Dimension B: Measure from the underside surface of kitchen unit to the bottom of the fixing bracket

Fig. 2



Dimension C: Measure from the underside surface of kitchen unit to the top of next unit door.

Unscrew and remove the nuts and washers from the top of the appliance door to remove the bracket.

Subtract **C** from **B** and put the fixing bracket (2) in place using this measurement for vertical position and place to the centre for horizontal position.

Fig. 3

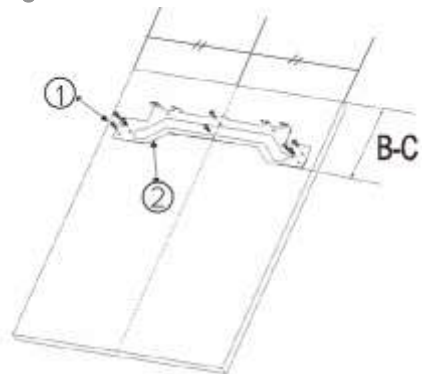

Secure the fixing bracket (2) using screws (1).

Place the decor door onto the appliance door by inserting adjustment bolts into the slots on the fixing bracket. Locate the washers and screw the nuts onto the adjustment bolts.

Fig. 4

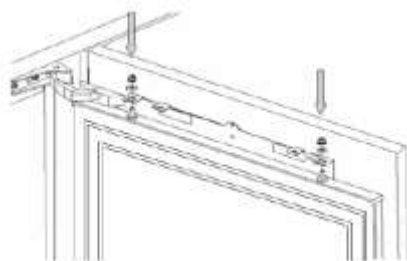

Aligning the decor door

Close the door and check the alignment with the other unit doors. Adjust the decor door by screwing or unscrewing the adjustment bolts for vertical adjustment (10) and by the help of the slots on the fixing bracket for other directions. Once the door is aligned, lock the screws into place by tightening the nut (8) as shown in Fig. 5.

Fig. 5

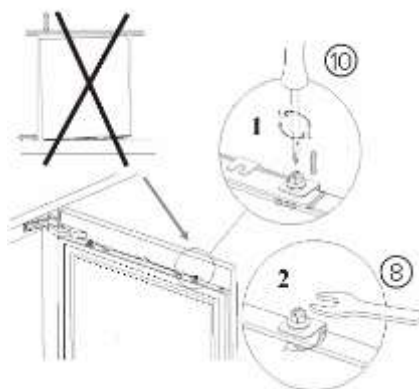

Fitting the decor door base fixings

With the appliance door open, locate the metal decor door base fixing brackets and screw the fixings to the decor door. You may need to remove and re-fit these brackets depending upon the decor door used.

Fitting the decorative cover

Re-fit the decorative cover that you removed in the first step, on to the decor door fixing bracket. Check that the whole door assembly operates smoothly and that the freezer door is still creating a seal.

Ensuring the door seals correctly

It is normal for the seal to be compressed after the door has been reversed. With the door closed, use a hair dryer to expand the seal and fill the gap between the door and the body of the appliance. Take care not to use the hair dryer too close to the appliance, which could damage the seal. A distance of approximately 10 cm should be adequate. When completed, allow the seal and door to cool before touching them. Once done, the seal will remain in position.

APPENDIX 2: FOOD STORAGE GUIDE

Meat & Fish	Preparation	Maximum storage time (months)
Steak	Wrap in foil	6-8
Lamb meat	Wrap in foil	6-8
Veal roast	Wrap in foil	6-8
Veal cubes	In small pieces	6-8
Lamb cubes	In pieces	4-8
Minced meat	In packaging without spices	1-3
Giblets (pieces)	In pieces	1-3
Bologna sausage/salami	Should be kept packaged even if it has a membrane	
Chicken and turkey	Wrap in foil	4-6
Goose and duck	Wrap in foil	4-6
Deer, rabbit, wild boar	In 2.5 kg portions or as fillets	6-8
Freshwater fish	After cleaning the bowels and scales of the fish, wash and dry it. If necessary, remove the tail and head.	2
Lean fish		4
Fatty fish		2-4
Shellfish	Clean and in a bag	4-6
Caviar	In its packaging, or in an aluminium or plastic container	2-3
Snails	In salty water, or in an aluminium or plastic container	3

NOTE!

Thawed frozen meat should be cooked as fresh meat. If the meat is not cooked after defrosting, it must not be re-frozen

Vegetables and Fruits	Preparation	Maximum storage time (months)
String beans and beans	Wash, cut into small pieces and boil in water	10-13
Beans	Hull, wash and boil in water	12
Cabbage	Clean and boil in water	6-8
Carrot	Clean, cut into slices and boil in water	12
Pepper	Cut the stem, cut into two pieces, remove the core and boil in water	8-10
Spinach	Wash and boil in water	6-9
Cauliflower	Remove the leaves, cut the heart into pieces and leave it in water with a little lemon juice for a while	10-12
Eggplant	Cut into pieces of 2cm after washing	10-12
Corn	Clean and pack with its stem or as sweet corn	12
Apple and Pear	Peel and slice	8-10
Apricot and Peach	Cut into two pieces and remove the stone	4-6
Strawberry and blackberry	Wash and hull	8-12
Cooked fruits	Add 10 % of sugar to the container	12
Plum, cherry, sourberry	Wash and hull the stems	8-12

	Maximum storage time (months)	Thawing time at room temperature (hours)	Thawing time in oven (minutes)
Bread	4-6	2-3	4-5 (220-225°C)
Biscuits	3-6	1-1,5	5-8 (190-200°C)
Pastry	1-3	2-3	5-10 (200-225°C)
Pie	1-1,5	3-4	5-8 (190-200°C)
Phyllo dough	2-3	1-1,5	5-8 (190-200°C)
Pizza	2-3	2-4	15-20 (200°C)

Dairy products	Preparation	Maximum storage time (months)	Storage conditions
Packet (homogenized)	In its own packet	2-3	Pure Milk – in its own packet
Cheese - excluding white cheese	In slices	6-8	Original packaging may be used for short-term storage. Keep wrapped in foil for longer periods.
Butter, margarine	In its packaging	6	

Ciao! MODENA

www.modena.com