

# **User Manual Book Water Dispenser**

DD 7315 W  
DD 7315 L

# TABLE OF CONTENT

Part 1: Safety Information	3
Precautions	3
Environmental Notice	4
Part 2: Name of Parts	5
Part 3: Quick Start Guide	6
Installation	6
How to Use	7
Ozone (O3) Sterilization	7
Part 4: Maintenance	8
Cleaning and Maintenance	8
Part 5: Troubleshooting	8
Part 6: Specification	10

This guide book explains everything you need to know about your new product. Please contact our Customer Care should you need further assistance through [www.modena.com](http://www.modena.com).

## PART 1: SAFETY INFORMATION

Read the user manual book carefully!

- Do not try to install or turn on the unit without having read the indicated safety precautions in this manual.
- The dispenser heats water to a temperature of 90°C. It can cause severe scalding. Please operate it carefully.
- Do not disassemble the electrical parts of this appliance. Any repairs done by an unauthorized person may cause serious injuries or properties incident.
- The adult should supervise the children in order to make sure the children can not play with the appliance.
- The appliance is not intended for use by persons(including children) with reduced physical, sensory or mental capabilities, or lack of experience and knowledge, unless they have been given supervision or instruction concerning use of the appliance by a person responsible for their safety.
- This appliance is intended to be household use only. Usage outside the intended use or excessive use may void the warranty.
- Do not modify the power cord. If the power cord is damaged, it must be replaced by technician with a replacement cable according to the appliance specification
- To avoid danger of suffocation, keep plastic bag away from babies and children.

### Precautions

- Destroy the carton, plastic bag and other packing materials after the dispenser is unpacked. Children might use them for play.
- Children require supervision when using the dispenser
- If available, it is recommended to install the anti-tilt bracket at the back side of this water dispenser to prevent the dispenser from falling down which could cause injury.
- Plug the water dispenser directly into the socket and ensure secure connection
- The unit requires proper grounding and the correct voltage
- An appropriate length of power cord is provided to reduce the risks of becoming entangled in, or tripping over a longer cord.

- Do not use an extension cord or plug adaptor. Failure may cause electric shock or risk of fire
- Choose a place that is near a grounded electrical socket. Keep the dispenser at least 20 cm away from walls and other appliances and furniture on all 4 sides.
- Do not place the water dispenser sitting over the power cord.
- Do not pull out or insert the plug with wet hands to avoid electric shock.
- Use the switch when turning the heating/cooling On/Off. Located on the back side of water dispenser.
- Do not fasten, twist or tie the power cord. If the power cord is damaged, it should be replaced by the manufacturer, service technician or a qualified person to prevent any risk.
- Keep the unit in a dry place and away from direct sunlight. Do not place the machine on paper or foam. Do not place anything flammable beside this machine.
- To avoid damage to the unit, do not plug the power cord or turn on the heating switch until the water can flow out from the hot water spout when the hot water button be activated.
- Unplug the unit when the unit will not be used for a long period for the reason of saving electricity.
- Never turn the unit upside down or tilt it more than 45°
- Never use organic liquids polishing chemical to clean the machine.
- The thermostat to control temperature has been set up by manufacturer. There is no need to adjust it yourself.

## Environmental Notice



The packaging material used is recyclable. We recommend that you separate plastic, paper and cardboard and give them to recycling agents. To help preserve the environment, the refrigerant used in this product is R134a (Hydrofluorocarbon - HFC), which does not affect the ozone layer and has little impact on the greenhouse effect.

According to WEEE (Waste of Electrical and Electronic Equipment) guidelines, waste from electrical and electronic devices should be collected separately. If you need to remove of this appliance in the future, do not throw it away with the rest of your domestic garbage. Instead, please take the appliance to the nearest WEEE collecting agents, where available.

## PART 2: NAME OF PARTS

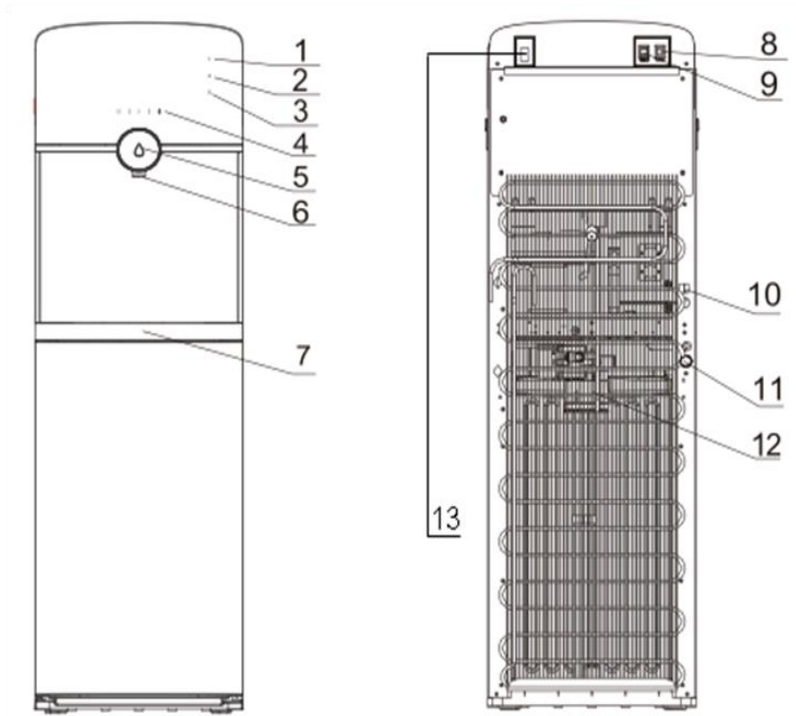

Note:

- |                             |                       |
|-----------------------------|-----------------------|
| 1. Ozone (O3) Indicator     | 8. Heater switch      |
| 2. Heating indicator        | 9. Cooling switch     |
| 3. Cooling indicator        | 10. Power cord        |
| 4. Water temperature button | 11. Water drain hole  |
| 5. Dispense button          | 12. Condenser         |
| 6. Water tap                | 13. Ozone (O3) switch |
| 7. Front body               |                       |

Note: During water shortage, the hot water indicator (2) and cold water indicator (3) will blink at the same time

## PART 3: QUICK START GUIDE

### Installation

1. Before first use, leave the appliance for 1 hour to stabilize the refrigerant
2. Install the pipe to the water bottle and install the cover to the bottle tip.
3. Insert the bottle into the bottom cabinet and close the door
4. Plug the power cord into the power socket. Make sure that the power source is properly grounded to prevent current leakage. Turn on the switch in the back of the appliance
5. For first use, the inside of the appliance must be cleaned. Press the hot and cold water button. Make sure the water is dispensed from the tap. After the water is dispensed, wait for 20 minutes and remove the water bottle from the cabinet and drain the water from the unit by opening the drain water hole cover. Ensure that the power cord is unplugged when draining the water.
6. If the water is empty, turn of the heating switch before replacing the bottle with a new one



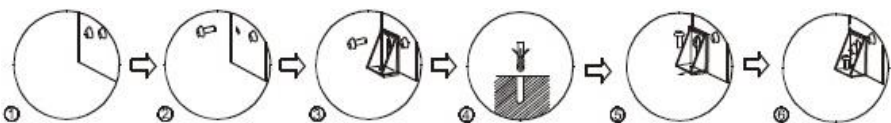
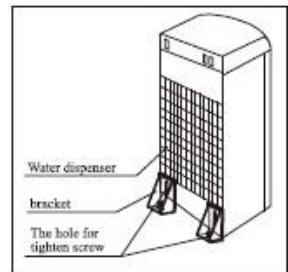

To prevent the dispenser from falling/wobbling, adjust the placement of the dispenser using the bracket:

1. Loosen the rear lower left corner bolt as shown in the picture.
2. Loosen also the bolts in the lower right corner of the back as shown in the picture
3. If the bracket has been removed, install the bolts on the lower left and lower right corners of the back of the dispenser.
4. Make a hole in the floor surface according to the placement of the dispenser
5. Install the bracket bolts on the floor.
6. Tighten the bolts on each bracket until tight.







## How to Use





### Dispensing hot water:

1. Position the bottle, glass, pitcher, or cooking pot below the spout
2. Press the hot water button , hot water indicator will turn on and  indicator will blink. To dispenser water, press  button
3. To stop dispensing, press  button again

### Dispensing normal water:

1. Position the bottle, glass, pitcher, or cooking pot below the spout
2. Press the hot water button , hot water indicator will turn on and  indicator will blink. To dispenser water, press  button
3. To stop dispensing, press  button again

### Dispensing cold water:

1. Position the bottle, glass, pitcher, or cooking pot below the spout
2. Press the hot water button , hot water indicator will turn on and  indicator will blink. To dispenser water, press  button
3. To stop dispensing, press  button again

## Ozone (O3) Sterilization

Press the O3 button located on the back of the dispenser to turn it on. Hold for 5 seconds and release to activate it. The O3 indicator light will light up for 1 hour. While the O3 indicator light is on, it is recommended not to take and drink water from the dispenser.

### **WARNING!**

The dispenser heats the water temperature up to 90°C. This can cause severe burns or scalding. Use it carefully!

## PART 4: MAINTENANCE

### Cleaning & Maintenance

1. Ensure the power cord is unplugged before performing cleaning and maintenance activity
2. Dispense the water from the unit until it's empty
3. Place a big bucket under the water drain hole on the back of the unit, unplug the drain cover and empty the remaining water from the tank
4. After it is completely dry, close the drain water cover.

## PART 5: TROUBLESHOOTING

Before contacting service center, check the following table:

Problem	Possible Cause	Recommended Action
Dispenser is not working	Power plug is plugged incorrectly Switch is in OFF condition	Ensure the dispenser is properly plugged into the power socket and the switch is turned ON.
The water is not hot or cold	<ul style="list-style-type: none"><li>• Hot or cold water is dispensed excessively in a short time</li><li>• The unit is not plugged</li></ul>	<ul style="list-style-type: none"><li>• Wait for a few minutes until the water is hot or cold</li><li>• Plug the power cord into the power socket and turn on the heating/cooling switch</li></ul>
Water is not being dispensed from water tap	<ul style="list-style-type: none"><li>• Water bottle is empty</li><li>• The pipe is clogged</li></ul>	<ul style="list-style-type: none"><li>• Replace the water bottle with a new one</li><li>• Turn of the switch for 4 hours and then turn the switch back ON</li></ul>
Loud noise	<ul style="list-style-type: none"><li>• Improper installation</li><li>• Compressor is operation</li><li>• Pump is operating</li></ul>	<ul style="list-style-type: none"><li>• Ensure that the unit is placed in an even and stable surface</li><li>• The compressor may produce sound when operating which is normal</li></ul>



<b>Problem</b>	<b>Possible Cause</b>	<b>Recommended Action</b>
		<ul style="list-style-type: none"><li data-bbox="725 213 986 312">• The pump may produce sound when operating which is normal</li></ul>

## PART 6: SPECIFICATION

Model	DD 7315 W	DD 7315 L
Color	White	Black
Type	Bottom Gallon	Bottom Gallon
Tank & pipe material	SUS 304	SUS 304
Hot water	4 L/hr ( $\geq 90^{\circ}\text{C}$ )	4 L/hr ( $\geq 90^{\circ}\text{C}$ )
Cold water	4 L/hr ( $\leq 10^{\circ}\text{C}$ )	4 L/hr ( $\leq 10^{\circ}\text{C}$ )
Special feature	Ozone (O3) Sterilization	Ozone (O3) Sterilization
Refrigerant	R134a/32g	R134a/32g
Heating power input (Watt)	385	385
Cooling rated current (Ampere)	1.0	1.0
Rated voltage	220V~50Hz	220V~50Hz
Product dimension (W×D×H)(mm)	310×370×1050	310×370×1050
Product weight (kg)	17	17

Design and specification can change without prior notice to improve the quality of the product. The illustration in this manual is schematic and can be different with your actual product. The values on label or in other documents are according to laboratory test and relevant standards. Values can vary depending on the actual operational and environmental condition of the product.

*Ciao!* **MODENA**

[www.modena.com](http://www.modena.com)

**PT MODENA INDONESIA**

Jl. Industri Raya I Blok D-8,  
Jatiuwung, Tangerang 15135