

MODENA

User Manual Book Oven

BO 9130 SAM

Table of Contents

PART 1: SAFETY WARNINGS	4
General Warning	4
Caution	4
Avoid The Following	5
General Usage	6
PART 2: NAME OF PARTS	7
PART 3: INSTALLATION	9
Important Warnings for Installation	9
Installation Under Counter	9
Installation in a High Cabinet	10
Installation Conditions	10
Placing and Securing the Oven	11
Electrical Connection	11
PART 4: HOW TO USE	12
Control Panel BO 9130 SAM	12
Cooking Feature	12
Digital Timer For BO 9130 SAM	14
Countdown (Alarm)	14
Cook time	15
End time	15
Cook time and End time combined	15
Indicator light	16
Using The Turnspit	16
Cooking Tips	17
PART 5: MAINTENANCE	18
Cleaning Oven	18
Replacing Oven Lamp	19

Disassembling/Assembling Oven Door	19
Disassembling the Door	19
Reassemble The Door	19
PART 6: TROUBLESHOOTING	20
PART 7: PRECAUTION	22
Advice and Precautions	22
General Safety Instructions	22
PART 8: SPECIFICATION	24
APPENDIX 1	25
APPENDIX 2	26

PART 1: SAFETY WARNINGS

General Warning

Read carefully all the instructions contained in this booklet. It provides you with important information regarding the safe installation, use and maintenance of the appliance as well as useful advice for getting the best out of your oven. Keep this booklet in a safe place for future reference. After removing the packing, check that the appliance is not damaged in any way.

Be careful not to leave the packing materials (plastic sheeting, expanded polystyrene etc.) where children can get at them, as they can be dangerous.

IMPORTANT

do not use the oven door handle to move the appliance, such as to remove it from the packaging

ATTENTION

- The oven is an appliance which, for its nature, becomes hot, especially in correspondence of the glass door.
- It is therefore a good rule that children do not approach the oven when it is functioning, particularly when the grill is used.

The first time you switch the oven on, acrid smelling smoke may appear. This is caused by the heating of the adhesive used on the insulation panels surrounding the oven. There is nothing unusual about this. If it happens, simply wait until the smoke disappears before putting any food in the oven. Never roast or bake on the oven base.

Caution

- This appliance is designed for non-professional, household use and its functions must not be changed.

- The electrical system of this appliance may be used safely only when it is correctly connected to an efficient earthing system in compliance with the safety standards currently in effect.
- MODENA will not be held liable for any damages that might arise out of incorrect installation or improper, incorrect or unreasonable use of the appliance.

The following items are potentially dangerous, and therefore, appropriate measures must be taken to prevent children and the disabled from coming into contact with them:

- Controls and the appliance in general.
- Packaging (bags, polystyrene, nails, etc.).
- The appliance immediately after use of the oven or grill due to the heat generated.
- The appliance when no longer in use (potentially dangerous parts must be made safe).

Avoid The Following

- Touching the appliance with wet parts of the body.
- Using the appliance when barefoot.
- Pulling on the appliance or the supply cord to unplug it from the electrical outlet.
- Obstructing the ventilation or heat dissipation slots.
- Allowing power supply cords for small appliances to come into contact with the hot parts of the appliance.
- Exposing the appliance to atmospheric agents (rain, sun).
- Using the oven for storage purposes.
- Using flammable liquids near the appliance.
- Using adaptors, multiple sockets and/or extension cords.
- Attempting to install or repair the appliance without the assistance of qualified personnel.

WARNING

- Accessible parts will become hot when in use. To avoid burns and scalds children should be kept away
- During usage, the appliance becomes hot, care should be taken to avoid touching heating elements inside the oven.

General Usage



- Only use the appliance to cook food, nothing else.
- Check the soundness of the appliance after it has been unpacked.
- Unplugged the appliance from the electrical mains if it is not functioning properly and before cleaning or performing maintenance.
- When the appliance is not used for an extended period of time, unplugged the appliance and close the gas cock (if present).
- Use cooking gloves to place cookware in the oven or when removing it.
- Always grasp the oven door in the centre because the ends may be hot due to the escape of hot air.
- Make sure that the control knobs are on the “o” setting when the appliance is not in use.
- Unplug the appliance when you decide not to use the appliance any longer.

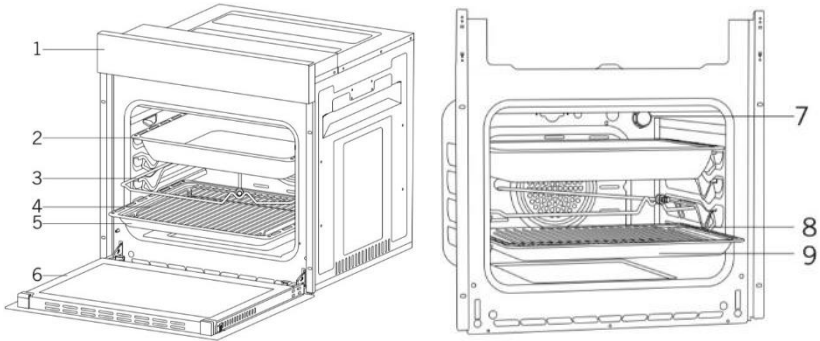



PART 2: NAME OF PARTS

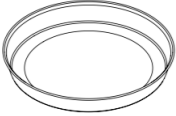

1. Control Panel
2. Deep Tray
3. Chicken roast skewer
4. Wire grill inside the tray
5. Standard tray
6. Oven door
7. Light
8. Grilling wire
9. Standard tray

ACCESSORIES (optional)

	<p>Deep tray Used for pastry, big roasts, watery foods. It can also be used as oil collecting container if you roast directly on grill with cake, frozen foods and meat dishes.</p>
	<p>Tray / Glass tray Used for pastry (cookie, biscuit etc.), frozen foods.</p>

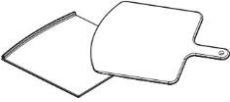
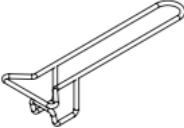
	<p>Circular tray Used for pastry frozen foods.</p>
	<p>Wire grill Used for roasting or placing foods to be baked, roasted and frozen into desired rack.</p>
	<p>Telescopic rail Trays and wire racks can be removed and installed easily, thanks to telescopic rails.</p>
	<p>In tray wire grill Foods to stick while cooking such as steak are placed on tray grill. Thus contact of food with tray and sticking are prevented.</p>
	<p>Pizza stone and peel They are used for baking pastries such as pizza, bread, pancake and removing baked food from the oven.</p>
	<p>Tray handle It is used to hold hot trays.</p>

PART 3: INSTALLATION

Important Warnings for Installation

Cooling fan shall take extra steam out and prevent outer surfaces of appliance from overheating during operation of the oven. This is a necessary condition for better appliance operation and better cooking. Cooling fan shall continue operation after cooking is finished. Fan shall automatically stop after cooling is completed.

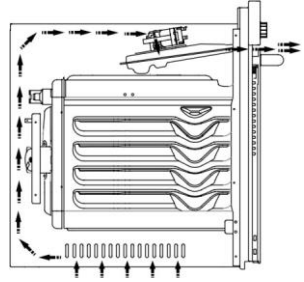

A space shall be left behind the compartment where you shall place your appliance to ensure efficient and proper operation of your appliance. This space shall not be neglected as it is necessary for the operation of the ventilation system of the appliance.

Installation and Assembly of the Oven

Operating space of the appliance shall be determined before starting the installation. Appliance shall not be installed on areas with high flow of air.

Handle the appliance with two persons at least. Do not drag the appliance to prevent damage to the ground.

Remove all transportation materials inside and outside of the packaging. Remove all materials and documents inside the product.

Installation Under Counter

Cabinet shall conform with dimensions specified in picture 2.

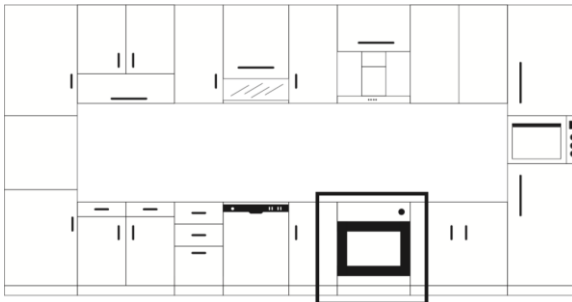

Picture 2

Installation in a High Cabinet

The cabinet shall comply with the dimensions given in picture 3.

In the rear part of the cabin, and at the top and bottom, spaces with the dimensions specified in the picture shall be ensured to provide the required ventilation.



Picture 3

Installation Conditions

The dimensions of the appliance are given in picture 3.

The furniture surfaces to be installed and the installation materials to be used shall resist a temperature of at least 100 °C.

To prevent the appliance from turning over, the cabinet to be installed shall be fixed and the cabinet floor shall be level.

The floor of the cabinet shall be strong enough to withstand a load of at least 60 kg.

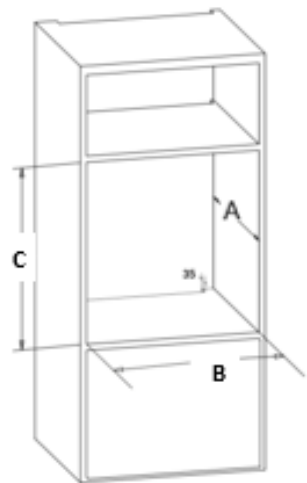

Picture 4

MODEL	A (mm)	B (mm)	C (mm)
BO 9130 SAM	550	860	472

Placing and Securing the Oven

Place the oven to the cabinet with two or more persons.

Make sure that the frame of the oven and the front of the furniture are properly aligned. The supply cord shall not be left under the oven or be stuck or bent between the oven and the furniture.

Secure the oven to the furniture using the screws supplied in the appliance. Screws shall be installed by putting them through the plastics attached on the frame of the appliance as shown in picture 5. The screws shall not be tightened too much. Otherwise, the screw holes may wear out. Check that the oven does not move after installation. If the oven has not been installed in accordance with the installation instructions, there is a risk of overturning during operation.

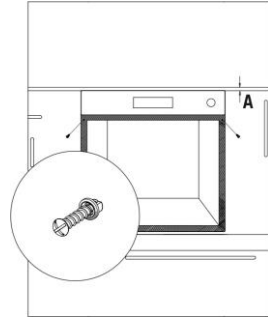

Picture 5

Electrical Connection

The place where the product is installed shall have proper electrical installation. The mains voltage shall comply with the rating given on the product type plate. Electrical connection for the appliance shall be made in accordance with local and national electrical regulations.

Disconnect the mains power before starting to install the product. Do not connect the product to the mains until the installation is finished.

At the front of the kitchen counter, there should be a space at least 5 mm high from the bottom of the counter

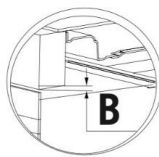
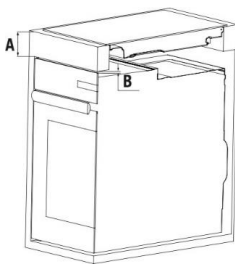

A	Min. 80 mm
B (Air outlet)	5 mm

PART 4: HOW TO USE



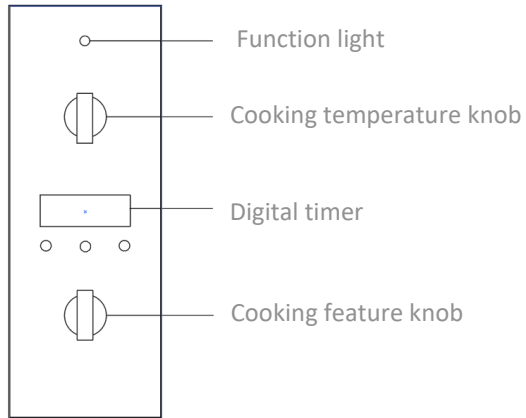



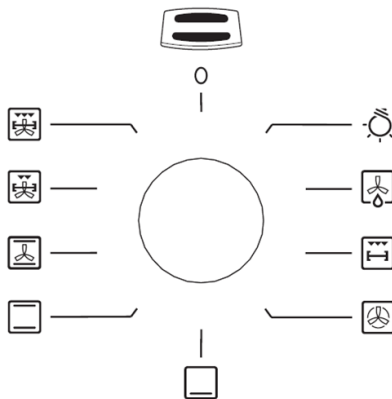

Control Panel BO 9130 SAM







The function light will turn when the oven is in heating process and will switch off when the oven already reaches the desired temperature.

Cooking Feature



	<p>Oven Lamp The light will automatically turn on in any available modes.</p>
	<p>Defrosting with fan The air at ambient temperature is distributed inside the oven for defrosting food more quickly and without proteins adulteration</p>
	<p>Total grill Hot temperature is emitted from the top with a full element heater. This feature is used to grilling large amount or large size. This mode also supports the turn spit usage (rotisserie).</p>
	<p>Back element + oven fan (Convection oven) Both the fan and the circular heating elements operate together. The hot air distributed inside the oven. This is ideal for cooking several pastries types.</p>
	<p>Lower heating element This position will allow the lower heating element to come on and it is recommended for finishing the cooking of food (in baking trays) which is already superficially well-cooked but still soft inside.</p>
	<p>Convection heating This mode allows the upper heating element and lower heating element come on. Hence, the heat will be distributed uniformly from top to the bottom.</p>
	<p>Convection heating with fan This mode combines both top and bottom heating element and also the fan. This feature increases the effectiveness of the heating process throughout the oven and also prevents foods from burning on the surface, allowing the heat to penetrate into the food.</p>
	<p>Fan assisted medium grill In this mode, the central top heating element will be activated along with the fan. This mode allows heat to penetrate the internal side of the food, and avoid the formation of the charred on the food surface. This mode also supports the turn spit usage (rotisserie).</p>
	<p>Fan assisted total grill All the heating elements will be activated along with the fan intensively. This feature increases the effectiveness of the heating process throughout the oven and also prevents foods from burning on the surface, allowing the heat to penetrate into the food. This mode also supports the turn spit usage (rotisserie).</p>

Digital Timer For BO 9130 SAM

		<p>Countdown indicator (Alarm)</p> <p>To set a countdown (alarm), a signal sound after the time has ended. This function does not affect the operation of the oven.</p>
		<p>Time indicator</p> <p>To set, change and check the time.</p>
		<p>Cook Time indicator</p> <p>To set how long the oven is to be in use.</p>
		<p>End Time indicator</p> <p>To set when the oven is to be switched off again.</p>

Before using oven for the first time, set and change the hours according to the current time. The oven only operates when the time has been set. When the appliances have been connected to the electrical supply or where there has been a power cut, the power indicator Time flashes automatically.

1. To change the time that has already been set, press the selection button repeatedly, until the function indicator Time flashes.
2. Set the current time using Plus or Minus button.

After approx. 5 seconds, the flashing stops and the clock displays the time of day set. The oven is now ready to use.

The time can only be changed if neither of automatic functions (Cook Time or End Time) have been set.

Countdown (Alarm)

1. Press Selection button repeatedly, until the function indicator Countdown flashes.
2. Using the Plus or Minus button, set the required Countdown (max. 2 hours 30 minutes).

After approx. 5 seconds, the display shows the remaining time. The function indicator Countdown will light up.

When the time has ended, the function indicator flashes and buzzer will ring for 2 minutes. Press any button to switch off the signal.

Cook time

1. Press Selection button repeatedly, until the function indicator Cook Time flashes.
2. Using the Plus or Minus button, set the required cooking time.

After approx. 5 seconds, the display returns to the current time. The function indicator Cook time will light up.

When the time has ended, the function indicator will flash, an acoustic signal will sound for 2 minutes and the oven will switch itself off. Press any button to switch off the signal and the program time.

End time

1. Press Selection button repeatedly, until the function indicator End time flashes.
2. Using the Plus or Minus button, set the required switch-off time.

After approx. 5 seconds, the display returns to the current time. The function indicator End time will light up.

When the time has ended, the function indicator will flash, an acoustic signal will sound for 2 minutes and the oven will switch itself off. Press any button to switch off the signal and the program me.

Cook time and End time combined

Cook time and End time can be used simultaneously, if the oven is to be automatically switched on and off at a later time.

1. Using the function Cook time set the period of time that the dish requires to cook. Example, the cooking time is 1 hour.
2. Using the function End time, set the time at which the dish is to be ready. Example, the dish is to be ready at 14:05.
3. The function indicators Cook time and End time light up and the time is shown in the display. Example, the current time is 12:05.
4. The oven will automatically switch itself on at the appropriate time as calculated. Example, oven automatically switch itself on at 13:05 and will switch itself off when the cooking time set has elapsed.

Example, at 14:05 (according to the time that has been set previously, see no. 2)

Indicator light

- The indicator will be light up until the selected temperature when turning the thermostat knob, and will switch off when the selected temperature is reached.
- The indicator for cooling fan will light up when the cooling fan is switch on.

Using The Turnspit

the rotisserie can be used in combination with the grill. After fitting the food on to the spit S, block it with the two forks F. then proceed as follows:

- Fit the knobs protection as shown in (fig. 1)
- Position the spit support as shown in (fig. 2)
- Fit the end of the spit into the motor M at the back of the oven (fig. 2).
- Fit the support into the circular groove in the spit.
- Unscrew and remove handle A.
- Place the oven tray with a little water on the lowest shelf of the oven.
- Turn the knob to the mode which enables to use rotisserie to start up the motor.
- Partially close the oven door (fig. 1b).
- When the cooking time is up, screw the handle on the spit and remove everything from the oven. If necessary, use an oven glove to avoid any burn.

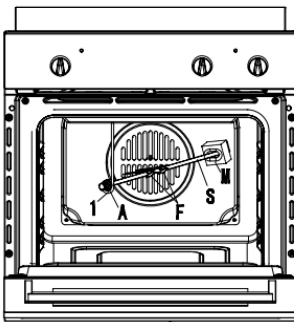
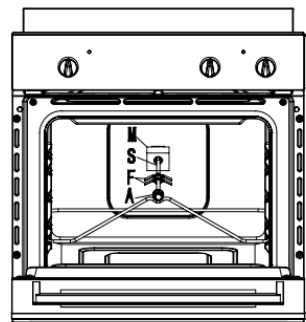
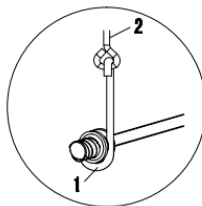

FIG 1



FIG

Cooking Tips

Faults	Causes	Remedies
The upper crust is dark and the lower part too pale	Not enough heat from the bottom	Use the natural convection position Use deeper cake tins Lower the temperature Put the cake on a lower shelf
The lower part is dark and the upper crust too pale	Excessive heat from the bottom	Use the natural convection position Use lower side tins Lower the temperature Put the cake on a higher shelf
The outside is too cooked and the inside not cooked enough	Too high temperature	Lower the temperature and increase the cooking time
The outside is too dry even though of the right color	Too low temperature	Increase the temperature and reduce the cooking time.

PART 5: MAINTENANCE

Cleaning Oven

To extend the life of your oven, it must be cleaned frequently, keeping in mind that:

- Do not use steam equipment to clean the appliance.
- To protect against the risk of electrical shock, do not immerse the unit, cord or plug in water or other liquid or sprinkle water to clean the appliance!
- Don't clean the appliance when it is still hot! The inside and external surface of the oven should preferably be cleaned by damp cloth when it is cooled down.
- Wash all accessories in hot sudsy water or in a dishwasher, wipe dry with a paper or cloth towel.
- If you use your oven for an extended period of time, condensation may form. Dry it using a soft cloth.
- There is a rubber seal surrounding the oven opening which guarantees its perfect functioning. Check the condition of this seal on a regular basis. If necessary, clean it and avoid using abrasive products or objects to do so. Should it become damaged, please contact your nearest After-sales Service Centre. We recommend you avoid using the oven until it has been repaired.
- Never line the oven bottom with aluminium foil, as the consequent accumulation of heat could compromise the cooking and even damage the enamel.
- Clear the glass door using damp cloth and dry it with a soft cloth.

Do not use harsh abrasive cleaners or sharp metal scrapers to clean the oven door glass since they can scratch the surface, which may result in shattering of the glass.

Replacing Oven Lamp

- Unplug your oven!
- Unscrew the glass cover attached to the lamp holder
- Unscrew the lamp and replace it with another high-temperature lamp (300°C) with the following characteristics:
 - Voltage: AC 220 V – 240 V
 - Wattage: 15W
 - Socket: E 14
- Remount the glass cover and reconnect the appliance to the power supply

Disassembling/Assembling Oven Door

Disassembling the Door

- Open the door completely and lift the 2 levers “B” (fig 3).
- Now, shutting the door slightly, you can lift it out by pulling out the hooks “A” as shown in figure 3.

Reassemble The Door

- With the door in a vertical position, insert the two hooks “A” into the slots.
- Ensure that seat “D” is hooked perfectly onto the edge of the slot (move the oven door backwards and forward slightly).
- Keep the oven door open fully, unhook the 2 levers “B” downwards and then shut the door again.

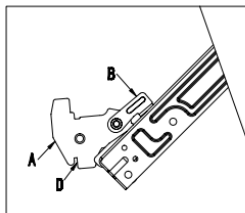

FIG 3

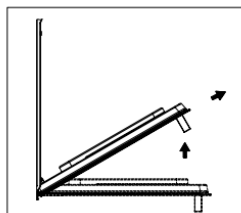

FIG 4

PART 6: TROUBLESHOOTING

Check several things below before contacting our Call Center, if there are problems with your gas oven:

Problem	Possible Cause	Recommended Action
Oven does not operate.	Power supply not available.	Check for power supply.
Oven stops during cooking	Plug comes out from the wall socket.	Re-install the plug into wall socket.
Turns off during cooking	Too long continuous operation.	Let the oven cool down after long cooking cycles
	Cooling fan not operating	Listen the sound from the cooling fan.
	Oven not installed in a location with good ventilation.	Make sure spaces specified in operating instructions are maintained.
	More than one plugs in a wall socket.	Use only one plug for each wall socket.
Outer surface of the oven gets very hot during operation.	Oven not installed in a location with good ventilation.	Make sure spaces specified in operating instructions are maintained.
Oven door is not opening properly.	Food residues jammed between the door and internal cavity	Clean the oven well and try to re-open the door
Internal light is dim or does not operate	Foreign object covering the lamp during cooking	Clean internal surface of the oven and check again
	Lamp might be failed.	Replace with a lamp with same specifications
Electric shock when touching the oven	No proper grounding	Make sure power supply is grounded properly
	Ungrounded wall socket is used	
Water dripping	Water or steam may generate under certain conditions depending on the food being cooked. This is not a fault of the appliance.	Let the oven cool down and than wipe dry with a cloth.
Steam coming out from a crack on oven door		
Water remaining inside the oven.		

Problem	Possible Cause	Recommended Action
The cooling fan continues to operate after cooking is finished.	The fan operates for a certain period for ventilation of internal cavity of the oven.	This is not a fault of the appliance; therefore you don't have to worry.
Oven does not heat.	Oven door is open.	Close the door and restart.
	Oven controls not correctly adjusted.	Read the section regarding operation of the oven and reset the oven.
	Fuse tripped or circuit breaker turned off.	Replace the fuse or reset the circuit breaker. If this is repeating frequently, call an electrician.
Smoke coming out during operation.	When operating the oven for the first time	Smoke comes out from the heaters. This is not a fault. After 2-3 cycles, there will be no more smoke.
	Food on heater.	Let the oven to cool down and clean food residues from the ground of the oven and surface of upper heater.
When operating the oven burnt or plastic odor coming out.	Plastic or other not heat resistant accessories are being used inside the oven.	At high temperatures, use suitable glassware accessories.
Oven does not cook well.	Oven door is opened frequently during cooking.	Do not open oven door frequently, if the food you are cooking does not require turning. If you open the door frequently internal temperature drops and therefore cooking result will be influenced.

PART 7: PRECAUTION

Advice and Precautions

This unit is designed and manufactured in compliance with international safety standards. Warnings and instructions below is for safety reasons and must be read and followed carefully.

General Safety Instructions

- The unit is designed for household and indoors use and is not intended for commercial use or industry.
- Unit should not be installed in an open area. It is very dangerous to let the unit exposed to rain.
- When moving and installing the unit, always use the attached handrail on the oven.
- Do not touching the side of the unit with wet and bare feet or wet hands.
- Unit should be used only by adults to prepare the dish according to the instructions in the guide book.
- Do not touch the heating element or a particular part of the oven door when the unit is used, since some parts become very hot. Keep children away from the oven and do not touch the hot parts of the electrical wiring directly.
- Make sure other electronic appliances are not in contact with the hot parts of the oven.
- The room for ventilation and heat dissipation should not be obstructed.
- Always grasp the middle part of the oven handle, the end part of the handle could be hot.
- Always wear gloves when placing or removing the cutlery into or out of the oven.
- Do not use aluminum foil to line the oven bottom.
- Do not put flammable materials in the oven, if the unit is accidentally turned on, these material can burn.
- Always make sure the knob on the “●”/“○” position when the unit is not in use.
- When you disconnect the power cord, always pull from the cable head, do not pull the cord.
- Always unplug the power cord from its source when doing maintenance or repairing to the unit. If there is damage on the unit, however, do not try to fix it by yourself. Repairs that carried out by inexperienced person could potentially

cause injury or further damage to the unit. Contact MODENA authorized Call Center for repair.

- Do not put or lean heavy objects on the oven door.
- Do not let the children play with the unit.
- Units are not to be used by people (including children) with a limited physical abilities, sensory, or mental; or lack of experience and knowledge about these products, unless they have been given supervision or instruction concerning the use of tools by a person responsible for their safety.
- Always turn off the oven before removing the oven rack and plates.
- During the cooking process, fats or oils should be treated cautiously because this material is likely to cause a fire when reaching a certain temperature.
- When you smell gas, immediately release the regulator from the gas tank, do not light a fire and immediately contact MODENA Call Center.
- Frequently check the gas hose, to make sure that gas hose is far from hot surface, and not in bent position. Make sure the outer surface of hose isn't cracked so that can be a leakage.
- Always remember that certain parts of the gas stove may feel hot for a long time (around 30 minutes) after you turn off the gas stove.
- Perform a routine service on your built-in oven every 3 (three) months, so any abnormalities on your built-in oven can be detected and repaired immediately.

PART 8: SPECIFICATION

MODEL	BO 9130 SAM
Oven type	Electric Oven
Cooking program	9
Color	Satin Stainless
Oven capacity (liter)	110
Grill	Electric
Oven	Electric
Convection fan	Yes
Turn spit	Yes
Door glass	3 Layers
Oven Light	Yes
Thermostat	Yes
Timer	Yes
Oven tray	Yes
Voltage (Volt)	220-240
Lower heater	1300 W
Back heater	2800 W
Upper Heater	1050 & 2000 W
Product dimension (L x W x H) mm	895 x 568 x 475
Cut-out dimension (L x W x H) mm	860 x 550 x 472
Weight (Kg)	39,4

APPENDIX 1

Cooking Type	Oven temperature (°C)	Cooking time (minutes)
<i>PASTRY</i>		
Cake	175	40 – 50
Sponge cake	170	30
Fruit tart	180 – 190	20 – 30
Paradise cake	160	40 – 45
Margaret cake	160	40 – 45
Chocolate cake	160	25 – 35
Meringue	100	90
Puff pastry	200	20
<i>MEAT</i>		
Roasted beef – 1.5 kg	190	20 – 25
Roasted veal – 1 kg	150 – 160	30 – 35
Roasted lamb – 1.5 kg	190	30
<i>POULTRY</i>		
Roasted pigeon	150 – 160	45
Turkey – 2 kg	175	180 – 240
Goose – 4 kg	200	240 – 270
Duck – 2.5 kg	175	90 – 150
Chicken – 1.5 kg	175	120 – 150
<i>FISH</i>		
Trout	200	15 – 25
Cod-fish	190	50
<i>OTHER</i>		
Lasagna	200	40
Soufflé	180 – 200	20
Pizza	200	20

APPENDIX 2

Food	Time (minute)	
	1 st Side	2 nd Side
Sliced meat	6	4
Thick meat	8	5
Smal Fish	10	8
Big Fish	15	12
Sausage	12	10
Grill Sandwich	5	2
Small chicken	20	15

